

PLV DIGITALE
 ÉCRANS DYNAMIQUES
 TABLETTES TACTILES
 TOTEMS INTERACTIFS
 BORNES INTERACTIVES
 AFFICHAGE DYNAMIQUE
 TOTEMS TACTILES
 TABLES INTERACTIVES
 ECRANS TRANSPARENTS
 MURS D'ÉCRANS
 DIGITAL BOOK
 TABLES TACTILES
 CONTENU INTERACTIF
 DÉVELOPPEMENT
 APPLICATIONS
 SITES WE
 TOTEMS TACT
 TABLES INTERA
 ECRANS TRANF
 MUP

PLV / STANDS EXPO

STANDS PARAPLUIE
 ENROULEURS
 BANNERS
 COMPTOIRS
 DRAPEAUX
 PLV CARTON
 AFFICHAGE
 TENTES
 COVERING
 PRÉSENTOIRS
 STOP-TROTTOIR
 CADRES TISSU
 PLEXIGLAS
 SIGNALÉTIQUE
 PORTE-BROCHURES
 SUR-MESURE
 MULTIDISPLAY
 STANDS PARAPLUIE
 ENROULEURS
 BANNERS
 COMPTOIR
 DRAPEAU
 COMF



PLV DIGITALE

BORNES & TOTEMS VIDEO	P.04
TOTEMS PC	P.10
BORNES TACTILES	P.12
TOTEMS TACTILES	P.16
TABLES TACTILES	P.20
DIGITAL BOOK / ÉCRANS	P.24
SUPPORTS TABLETTES/IPAD	P.26
ÉCRANS TRANSPARENTS	P.28
DÉVELOPPEMENT APPLIS	P.30

TABLES TACTILES
CONTENU INTERACTIF
DÉVELOPPEMENT
APPLICATIONS
SITES WEB
ÉCRANS DYNAMIQUES
DIGITAL BOOK
TABLETTES TACTILES
TOTEMS INTERACTIFS
BORNES INTERACTIVES
AFFICHAGE DYNAMIQUE
TOTEMS TACTILES
TABLES INTERACTIVES
ECRANS TRANSPARENTS
MURS D'ÉCRANS
DIGITAL BOOKS
TABLES TACTILES
CONTENU INTERACTIF

ÉCRANS TRANSPARENTS
MURS D'ÉCRANS
DIGITAL BOOK
TABLES TACTILES
CONTENU INTERACTIF
DÉVELOPPEMENT
APPLICATIONS
SITES WEB
ÉCRANS DYNAMIQUES
TABLES TACTILES
CONTENU INTERACTIFS
DÉVELOPPEMENT
APPLICATIONS
SITES WEB
DIGITAL BOOK

BORNES & TOTEMS VIDEO

TOTEMS LCD "Portland"

Idéal dans un espace réduit, cet élégant totem est intégralement personnalisable grâce à notre solution de magnets imprimés. Affichez photos et vidéos depuis le lecteur de carte mémoire intégré



TAILLES D'ÉCRAN
DISPONIBLES



CARACTÉRISTIQUES



TROLLEY
EN OPTION



PROFIL



FACE ARRIÈRE





**LECTURE VIDEO
AUTOMATIQUE**

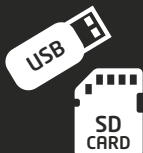

**LECTEUR
CARTES MÉMOIRES**



**HAUT-PARLEURS
INTÉGRÉS**



**TÉLÉCOMMANDE
INCLUSE**

Notre gamme VIDEO est équipée d'écrans multimédias permettant la lecture automatique de contenus audio et vidéo depuis un lecteur de cartes mémoires intégré.

TOTEMS FLYER

"Astoria"

Notre *best-seller* !
Combinez un totem LCD vidéo 19 ou 22"
avec porte-brochures et habillage quadri

TAILLES D'ÉCRAN DISPONIBLES



CARACTÉRISTIQUES



**HABILLAGE AIMANTÉ
EN OPTION**

**FLIGHT CASE
EN OPTION**



PROFIL

FACE ARRIÈRE



TOTEM FLYER VERTICAL

"Springfield"

TAILLES D'ÉCRAN
DISPONIBLES



HABILLAGE AIMANTÉ
EN OPTION

CARACTÉRISTIQUES



/ FACE ARRIÈRE



/ PROFIL



MÂTS LCD

"Gresham"

TAILLES D'ÉCRAN
DISPONIBLES



/ MATLCD4



/ MATLCD5

CARACTÉRISTIQUES



TROLLEY
EN OPTION



MATLCD3

REF	KAKEMONO	ACCESSOIRES
MATLCD3	375x1350mm	3x porte-brochures A4
MATLCD4	600x1470mm	2x porte-brochures A4
MATLCD5	600x1470mm	3x porte-produits (150x300mm)

TOTEM FULL HD VERTICAL

"Oregon"

TAILLES D'ÉCRAN
DISPONIBLES



CARACTÉRISTIQUES

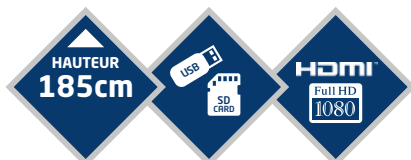

/ TOTEM 42"



/ TOTEM 55"

CAISSES DE TRANSPORT SUR ROULETTES
DISPONIBLES SUR LA PLUPART DE NOS MODÈLES



TOTEM FULL HD TWIN

"Hammond"

TAILLES D'ÉCRAN
DISPONIBLES



TOTEM 32" DESIGN "Brooks"

TAILLES D'ÉCRAN
DISPONIBLES



CARACTÉRISTIQUES



PORTE-BROCHURES
INTÉGRÉ

MARQUAGE QUADRI
EN OPTION



TOTEM 70" HD "Lakview"



TOTEM DESIGN 42" MIXTE "Medford"



VISUEL
RÉTRO-ÉCLAIRÉ



TOTEM CLEANER

"Stayton"

TAILLES D'ÉCRAN
DISPONIBLES



CARACTÉRISTIQUES



IDÉAL HÔTELS, PARKINGS, ...



BROSSES
CIRE-CHAUSSURES INTÉGRÉES

TOTEM TV 60"

"Yamhill"

TOTEM TV 80"

"Yamhill"



PIEDS ERARD® PRO
SUR ROULETTES

TOTEMS PC INTÉGRÉ

TOTEM PC 22" "Dallas"

TAILLES D'ÉCRAN
DISPONIBLES



CARACTÉRISTIQUES



TOTEM DESIGN PC 27" "Adrian"

TAILLES D'ÉCRAN
DISPONIBLES



CARACTÉRISTIQUES





PC
INTÉGRÉ

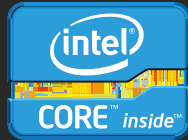

PROCESSEUR
INTEL CORE



ÉCRANS
FULL HD

Entrez dans notre gamme complète de totems vidéos avec PC intégré et donnez une autre dimension à vos présentations, en interne ou sur vos stands expo. Le totem a pour vocation d'attirer l'attention : lecture des éléments génériques, présentation globale de votre structure et de vos produits. Nous sommes à votre écoute pour vous conseiller et vous guider.

TOTEM DESIGN PRO *"Gladstone"*

TAILLES D'ÉCRAN
DISPONIBLES



CARACTÉRISTIQUES



TOTEM VERTICAL CADDIE *"John Day"*

TAILLES D'ÉCRAN
DISPONIBLES



CARACTÉRISTIQUES



IDÉAL
GRANDE DISTRIBUTION

PROTECTION CADDIE
EN OPTION



SOLUTIONS TACTILES

BORNES TACTILES

"Sheridan"

TAILLES D'ÉCRAN
DISPONIBLES



CARACTÉRISTIQUES 22"



CARACTÉRISTIQUES BORNE 42" XL

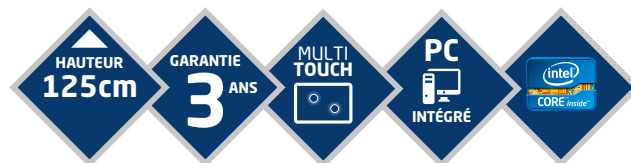

/ BORNE 22"



/ BORNE 42" XL



Quel que soit votre secteur d'activité, choisissez une de nos solutions tactiles et proposez à vos clients une expérience marketing unique et innovante. Bornes, totems, interfaces tactiles, nous vous accompagnons également dans le développement du contenu, contactez-nous vite !

BORNES TACTILES

"Newport"

TAILLES D'ÉCRAN DISPONIBLES



CARACTÉRISTIQUES

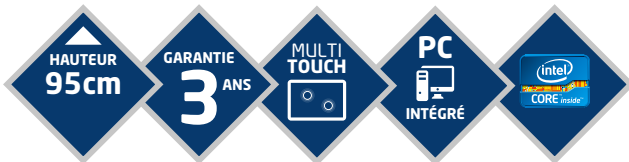

/ BORNE 32"



/ BORNE 55"



/ BORNE 42"

EN OPTION
HABILLAGE QUADRI



TRAPPE SÉCURISÉE
ACCÈS AU PC



PUPITRE 22" TACTILE

"Charleston"



TAILLES D'ÉCRAN
DISPONIBLES



CARACTÉRISTIQUES

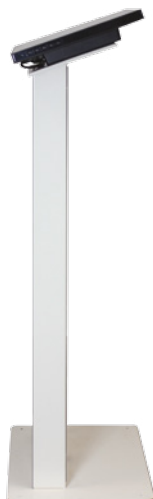
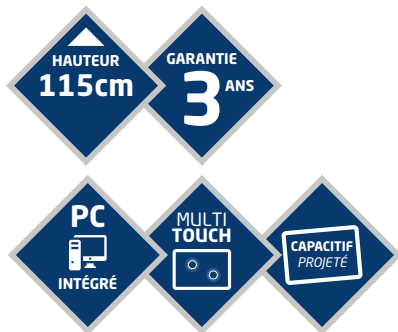

/ PROFIL



/ FACE ARRIÈRE



PUPITRE 27" TACTILE

"Cornelius"



TAILLES D'ÉCRAN
DISPONIBLES



CARACTÉRISTIQUES

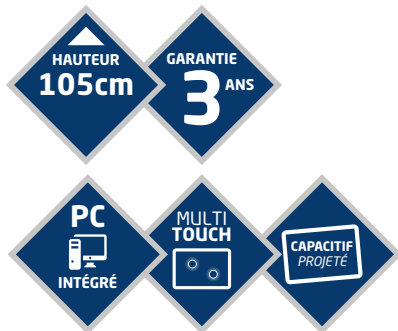

BORNE TACTILE DESIGN "Woodburn"

TAILLES D'ÉCRAN
DISPONIBLES



CARACTÉRISTIQUES

- HAUTEUR 112cm
- GARANTIE 3 ANS
- Intel CORE i5
- PC INTÉGRÉ
- MULTI TOUCH
- CAPACITIF PROJÉTÉ



BORNES TACTILES PMR

ENSEMBLE DE BORNES CORRESPONDANT AUX
NORMES PMR (PERSONNES À MOBILITÉ RÉDUITE)
CONSULTEZ-NOUS POUR PLUS D'INFORMATIONS !



**CONTACTEZ-NOUS
POUR + D'INFOS !**



TOTEMS TACTILES

"Sublimity"

CARACTÉRISTIQUES



TAILLES D'ÉCRAN DISPONIBLES



**EXTENSION DE GARANTIE
EN OPTION**



**TOTEMS LIVRÉS AVEC
CAISSE DE TRANSPORT
SUR ROULETTES**

TOTEM 22" TACTILE

"Aurora"



TAILLES D'ÉCRAN
DISPONIBLES



CARACTÉRISTIQUES

- HAUTEUR 152cm
- GARANTIE 3 ANS
- MULTI TOUCH
- PC INTÉGRÉ
- intel CORE inside
- 36kg

PORTE-BROCHURES
EN OPTION



TOTEM TACTILE PRO

"Sun River"



TAILLES D'ÉCRAN
DISPONIBLES



CARACTÉRISTIQUES

- HAUTEUR 157cm
- GARANTIE 3 ANS
- MULTI TOUCH
- PC INTÉGRÉ
- intel CORE inside
- 39kg



TOTEM 42" ROTATIF

"Hood River"

TAILLES D'ÉCRAN
DISPONIBLES



CARACTÉRISTIQUES

- HAUTEUR 187cm
- GARANTIE 1 AN
- MULTI TOUCH
- PC INTÉGRÉ
- intel CORE inside
- 68kg

ORIENTATION
PORTRAIT
OU PAYSAGE



TOTEM 55" TACTILE

"Ontario"

TAILLES D'ÉCRAN
DISPONIBLES



CARACTÉRISTIQUES



TOTEM KINECT

"Gold Beach"

TAILLES D'ÉCRAN
DISPONIBLES



CARACTÉRISTIQUES

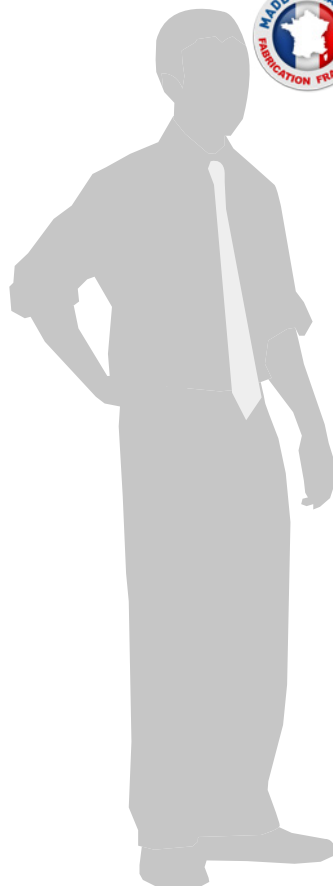

TOTEM NANO

"Adams"

TAILLES D'ÉCRAN DISPONIBLES



CARACTÉRISTIQUES

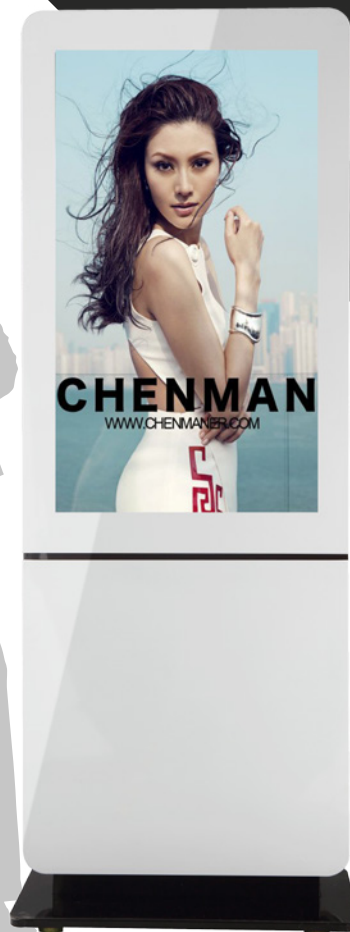

TOTEM TACTILE 65"

"Garibaldi"

TAILLES D'ÉCRAN DISPONIBLES



CARACTÉRISTIQUES

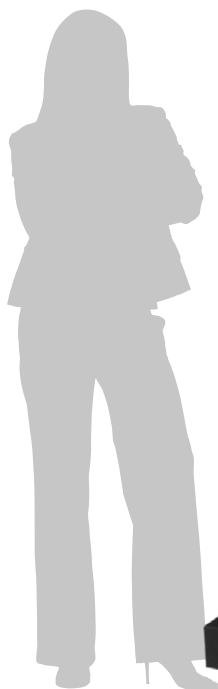

TABLE
TACTILE
"Kellogg"

32"
81cm

42"
106cm

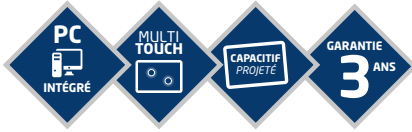

TABLE TACTILE
DESIGN
"Rockwood"

32"
81cm



TABLE
TACTILE KID
"Bend"

27"
68cm

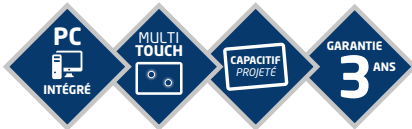

/ TABLE HAUTE

HAUTEUR
100cm

/ TABLE BASSE

HAUTEUR
58cm

CONCEPTION & DÉVELOPPEMENT
APPLICATIONS TACTILES

/ NOTRE ÉQUIPE DE
DÉVELOPPEURS ET DESIGNERS
VOUS ACCOMPAGNENT DANS
LA RÉALISATION DE CONTENU
POUR TABLES ET BORNES TACTILES

Jeu-concours, prise de contact,
présentation interactive de vos produits,
récupération de coordonnées, etc..
de nombreuses solutions sont disponibles !

CONTACTEZ-NOUS !



TOUCH TABLE ROUND



- Accès au contenu quelle que soit sa position
- Échange & partage de documents
- Travail collaboratif ultra efficace
- Créativité stimulée & convivialité



TABLE TACTILE RONDE **UNIQUE ET INNOVANTE!**

- Projecteur à LED Full HD intégré
- Couche tactile ultra-réactive
- + de 100 points de contacts en simultané
- Multi-utilisateurs / multi-applications
- Allumage 24H/24



NOUVEAUTÉ



DIGITAL BOOK

BROCHURE QUADRI AVEC ÉCRAN LCD INTÉGRÉ

4 TAILLES D'ÉCRANS
2.4", 4.3", 7" et 10"

MÉMOIRE INTERNE
128Mo à 8Go



DÉMARRAGE DE LA VIDÉO
à l'ouverture de la brochure

HAUT-PARLEURS
intégrés

RECHARGE PAR USB
autonomie 1h

ÉCRANS

ÉCRANS PROFESSIONNELS
AVEC LECTEUR DE CARTES MÉMOIRES
Système de fixation et personnalisation en option



ÉCRAN
7"



ÉCRAN
10"



EXEMPLES DE RÉALISATIONS



ECRAN
15"



**MARQUAGE
SUR DEMANDE**

**PATTES
DE FIXATION
SUR MESURE
POUR TOUS
TYPES DE
LINEAIRES**



BORNE IPAD DESIGN



BORNE IPAD ECO 2



BORNE IPAD ECO



BORNE IPAD INITIAL



BORNE IPAD PREMIUM



COMPATIBLES
APPLE IPAD®
SAMSUNG GALAXY TAB®

BORNES IPAD

IPAD DESK



CONCEPTION & DÉVELOPPEMENT APPLICATIONS MOBILES



NOTRE ÉQUIPE DE
DÉVELOPPEURS ET DESIGNERS
VOUS ACCOMPAGNE
DANS LA RÉALISATION
DE CONTENUS POUR
**IPHONE, IPAD ET
ANDROID**

Jeu-concours, prise de contact,
présentation interactive de vos produits,
récupération de coordonnées, etc..
de nombreuses solutions sont disponibles,
contactez-nous vite !

ÉCRANS TRANSPARENTS

Présentez vos produits de manière originale en les associant à une application tactile diffusée sur un écran transparent. **La réalité augmentée enfin accessible !**

CAISSON TACTILE
TRANSPARENT 42"



CAISSON SUR PIED TACTILE
TRANSPARENT 42"



FRIGO
TRANSPARENT 46"

MUR D'ÉCRANS

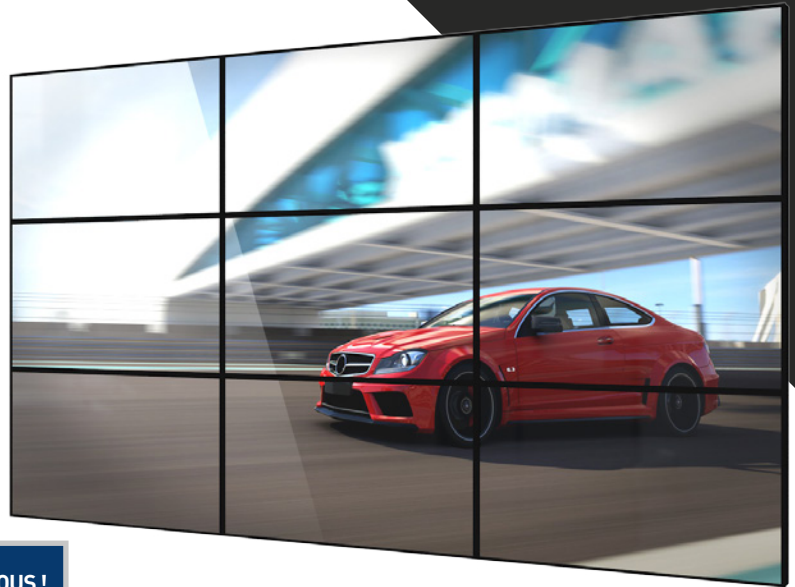

CONTACTEZ-NOUS !

DÉCOUVREZ NOS SOLUTIONS INNOVANTES POUR CRÉER VOTRE MUR D'IMAGES !

Marquez les esprits grâce à une image *Full HD* d'une clarté impressionnante sur des moniteurs à la pointe de la technologie



MAGIC MIRROR

VERSION MURALE
DISPONIBLE

Grâce à son détecteur de mouvement, la vidéo ou l'image affichée fonctionne en plein écran et, lorsqu'une personne se trouve à moins de 2m de celui-ci, se réduit au format désiré (avec sa télécommande)



CONCEPTION & DÉVELOPPEMENT APPLICATIONS TACTILES

NOTRE ÉQUIPE DE DÉVELOPPEURS
ET DESIGNERS VOUS ACCOMPAGNENT
DANS LA RÉALISATION DE CONTENU
POUR **TABLES ET BORNES TACTILES**



CONTACTEZ-NOUS !

PLV / STANDS EXPO

SIGNALETIQUE / COVERING	P.32
PLEXIGLAS	P.36
AFFICHAGE/PRÉSENTOIRS	P.39
CADRES TISSU TENDU	P.51
TENSION FABRIC	P.57
STANDS PARAPLUIE	P.58
PACKS EXPO	P.62
ROLL-UP	P.64
BANNERS	P.66
COMPTOIRS	P.68
SIGNALÉTIQUE PLAFOND	P.72
CENTRO	P.73
MULTIDISPLAY	P.78
EXTERIEUR	P.80
STOP-TROTTOIR	P.82
MEILLEURES VENTES	P.84

ENSEIGNES

Panneaux, totems, adhésifs, etc.
Il existe aujourd'hui une multitude de supports
pour mettre en valeur votre identité visuelle.



SIGNALÉTIQUE

La signalétique a une fonction de nommage dans l'espace urbain en précisant la fonction des bâtiments ou l'identité des occupants. Quant à la signalétique intérieure, elle permet d'orienter, identifier ou informer l'utilisateur.



MARQUAGE

Pensez à habiller vos véhicules et vitrines de lettrage simple ou d'un habillage partiel (semi covering).
Photos, textes, illustration, la création n'a pas de limite !

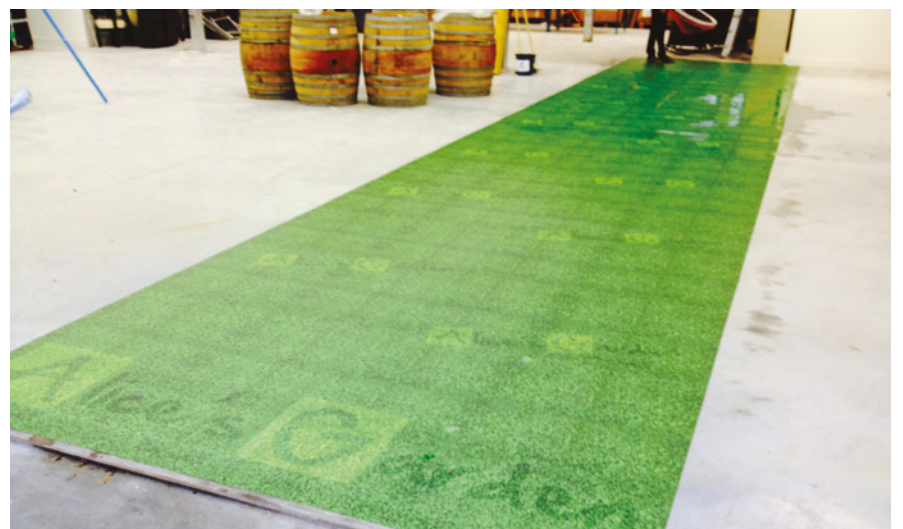

COVERING

Le total covering est un procédé qui consiste à appliquer un visuel numérique ou un vinyle teinté sur l'ensemble d'une carrosserie ou d'un objet



AVANT



APRÈS



AVANT



APRÈS



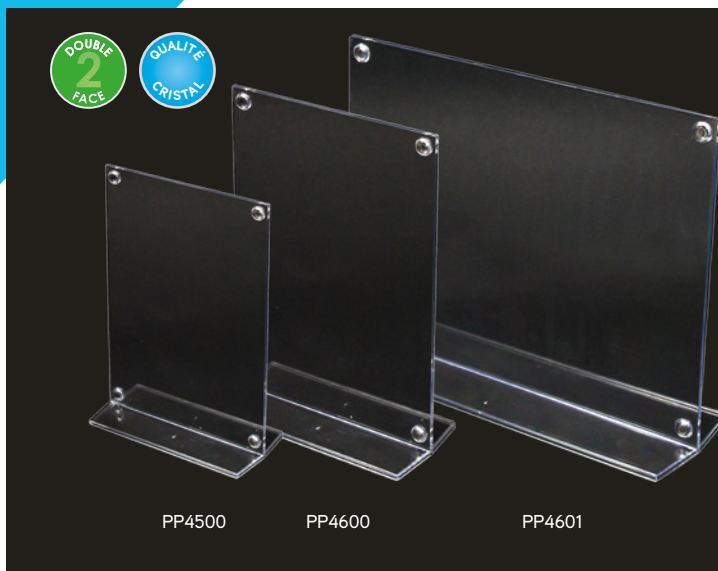

PORTE-VISUEL MAGNÉTIQUE

> PP4500 / PP4600 / PP4601

Présentoir de visuel double-face
Plexiglas 2 mm d'épaisseur
Système d'ouverture et fermeture magnétique

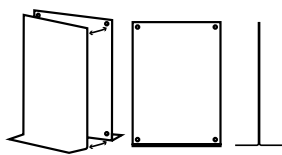

Réf	Dimensions	Cond.	Poids au carton
PP4500 - A5	148x210mm	20	5,2kg
PP4600 - A4V	210x297mm	10	4,8kg
PP4601 - A4H	297x210mm	10	4,8kg

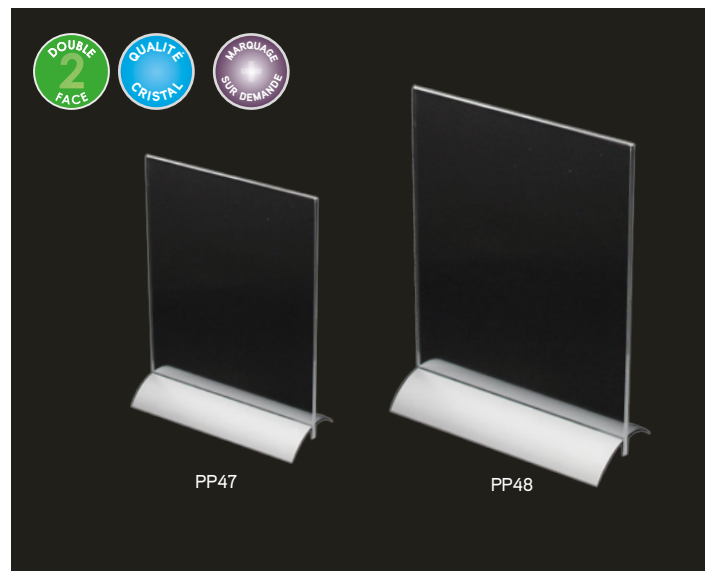

PORTE-VISUEL SOCLE ALU

> PP47 / PP48

Présentoir de visuel double-face sur socle aluminium
Plexiglas 2 mm d'épaisseur

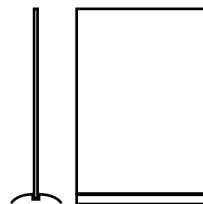

Réf	Dimensions	Cond.	Poids au carton
PP47 - A5	148x210mm	1	0,3kg
PP48 - A4	210x297mm	1	0,6kg

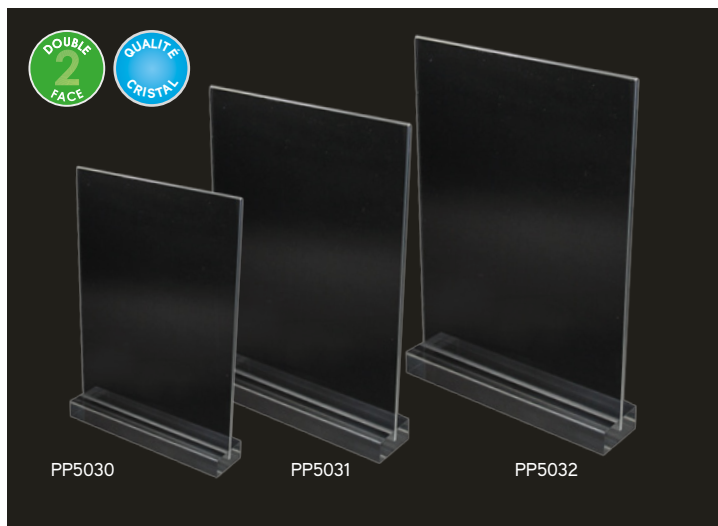

PORTE-VISUEL SOCLE MASSIF

> PP5030 / PP5031 / PP5032

Présentoir de visuel double-face sur socle massif
Porte-visuel: plexiglas 2 mm d'épaisseur

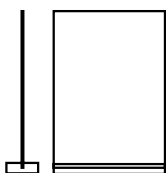

Réf	Dimensions	Cond.	Poids au carton
PP5030 - A5	148x210mm	1	0,4kg
PP5031 - A4	210x297mm	1	0,7kg
PP5032 - A3	297x420mm	1	1,6kg



CADRE MASSIF MAGNÉTIQUE

> PP5040 / PP5041 / PP5042

Présentoir de visuel double-face
réalisé en plexiglas massif
Système d'ouverture et
fermeture magnétique
Affichage en mode portrait ou
paysage au choix

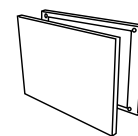
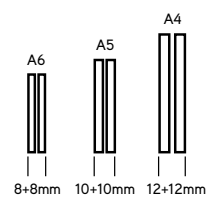

Réf	Dimensions	Cond.	Poids au carton
PP5040 - A6	148x105mm	1	0,6kg
PP5041 - A5	210x148mm	1	1,3kg
PP5042 - A4	297x210mm	1	2,7kg

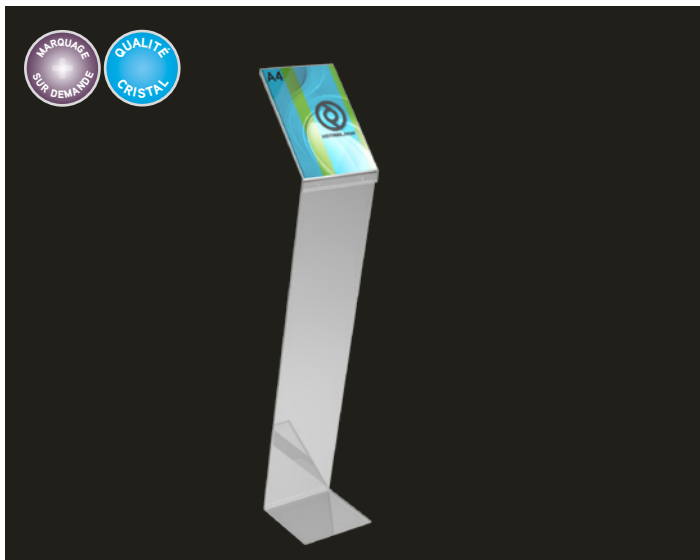

LUTRIN

> PP80 / PP81

Porte-affiches A4 ou A5
Idéal pour la présentation d'informations de fiches techniques dans des expos, salons, etc.
Lutrin réalisé en plexi 5 mm
Porte-affiches en 3 mm chants polis

En option:
Marquage logo (à partir de 50 pièces)

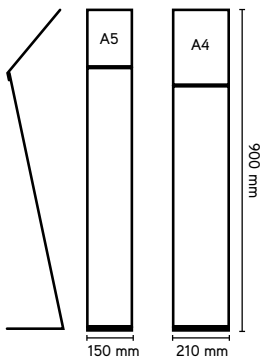

Réf	Cond.	Poids
PP80 - A5	1	5kg
PP81 - A4	1	6kg



PORTE-VISUEL INCLINÉ

> PP107 / PP108 / PP109

Présentoir de visuel injecté simple face

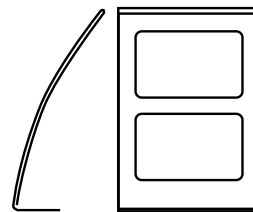

Réf	Dimensions	Cond.	Poids au carton
PP109 - A5	148x210mm	20	2,6kg
PP108 - A4V	210x297mm	10	2,6kg
PP107 - A4H	297x210mm	20	5,2kg



PORTE-VISUEL ET BROCHURES

> PP02

Présentoir de visuel A4
Porte-brochures 1/3 A4
Plexiglas 2 mm d'épaisseur

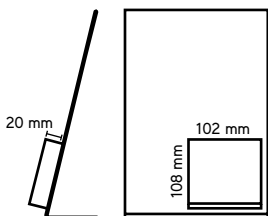

Réf	Dimensions	Cond.	Poids au carton
PP02 - A4	210x297mm	10	6kg

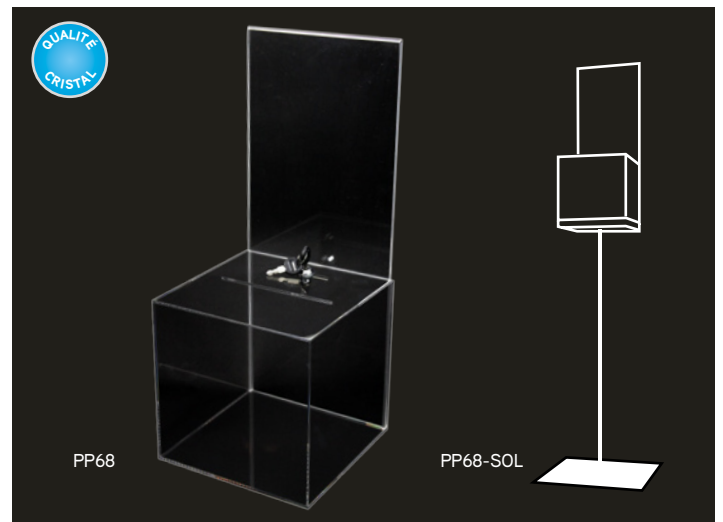

URNE JEU

> PP67 / PP68-SOL

Urne jeu sécurisée livrée avec sa clé
Fronton porte-visuel amovible
Réalisée en plexiglas 3 mm d'épaisseur

Version présentoir de sol disponible

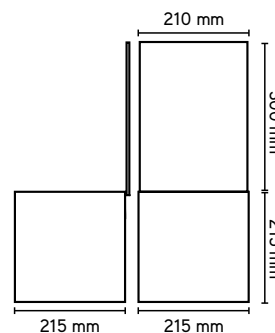

Réf	Cond.	Poids au carton
PP67	1	3kg
PP68-SOL	1	7kg

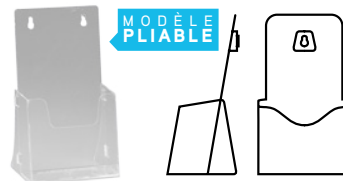

PORTE-BROCHURES
 > PP01 / PP10 / PP15 / PP9000
 Porte-brochures injecté
 Option séparateur pour modèle A4
 Double utilisation : murale et comptoir
 Bac haute capacité : 5 cm de profondeur

PP9000

Réf	Dimensions	Cond.	Profondeur du bac	Poids	Séparateur
PP01 - 1/3 A4	100x210mm	10	5cm	1,6kg	-
PP10 - A5	148x210mm	10	5cm	2,3kg	-
PP15 - A4	210x297mm	10	5cm	4,2kg	oui
PP9000	L.223mm	10	5cm	1,6kg	-



PORTE-BROCHURES 3 NIVEAUX
 > PP07 / PP1300 / PP17

Porte-brochures injecté 3 niveaux
 Double utilisation : murale et comptoir
 Option séparateur pour modèle A4
 (6x1/3 A4 / 3xA4)
 Bacs haute capacité : 5cm de profondeur

Réf	Dimensions	Cond.	Poids	Séparateur
PP07 - 1/3 A4	100x210mm	2	0,72kg	-
PP1300 - A5	148x210mm	2	0,94kg	-
PP17 - A4	210x297mm	2	1,88kg	oui



PORTE-BROCHURES ROTATIFS
 > PP100 / PP101 / PP102

Présentoir de brochures injecté rotatif
 3 compartiments
 Mât démontable en 3 parties sur roulettes
 Fronton porte-visuel inclus
 Conditionnement unitaire

	Réf	Poids
COMPTOIR	PP100 - 1/3 A4	1,85kg
	PP101 - A5	1,88kg
	PP102 - A4	2,78kg
SUR PIED	PP100 - 1/3 A4	5,40kg
	PP101 - A5	5,43kg
	PP102 - A4	6,33kg

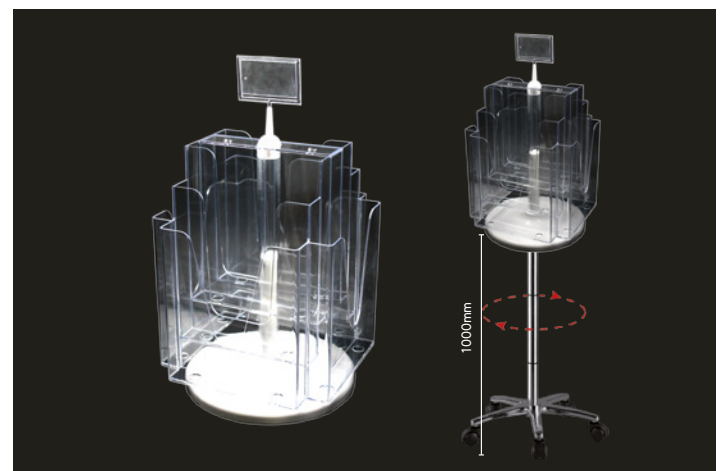
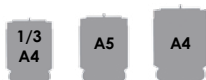

PORTE-BROCHURES ROTATIFS
 > PP103 / PP104 / PP105

Présentoir de brochures injecté rotatif
 8 compartiments
 Mât démontable en 3 parties sur roulettes
 Fronton porte-visuel inclus
 Conditionnement unitaire

	Réf	Poids
COMPTOIR	PP103 - 1/3 A4	1,26kg
	PP104 - A5	1,68kg
	PP105 - A4	5,20kg
SUR PIED	PP103 - 1/3 A4	4,78kg
	PP104 - A5	5,23kg
	PP105 - A4	8,75kg

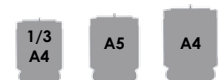



KIT RAILS

> AFSU01
 Kit rail aluminium snapframe haut et bas
 Profilé 28 mm
 Conditionnement unitaire
 Impression du visuel: nous consulter

En option:
 2 tiges de suspension métal de 50cm



CADRE MURAL XXL

> AFM07
 Cadre snapframe
 Profilé 46mm
 Coins carrés
 Livré avec vis + clé Allen
 Protection PVC anti-reflets
 Conditionnement unitaire
 Couleur: aluminium



Réf	Format	Poids
AFM07-70x100	70x100cm	4,2kg
AFM07-A0	A0	5kg
AFM07-100x140	100x140cm	6,4kg

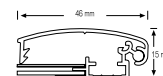

Réf	Format	Poids
AFSU01-42	420mm	310g
AFSU01-60	594mm	430g
AFSU01-90	841mm	640g
AFSU01-120	1200mm	890g
En option	Tiges de suspension métal x2	

CADRE ÉCO

> AFV03

Cadre très léger et économique
 Couleur: aluminium.
 Modèle au style original
 Affichage visible intérieur et extérieur
 Maintenu par des pinces crocodile
 Livré avec 2 ventouses

Disponible en version suspendue
 (tiges crochets ou ventouses)



CADRE MURAL SÉCURISÉ

> AFM19

Affichage sécurisé
 Idéal dans les zones de forte affluence
 Livré avec clé et visserie
 Profilé: 32mm. Couleur: argent
 Version étanche en option
 Conditionnement unitaire



Réf	Format	Poids
AFM19-A1	A1	3,2kg
AFM19-A0	A0	6kg

CADRE MURAL

> AFM03

Cadre snapframe
 25 mm de profilé
 Coins carrés. Livré avec vis
 Affiche papier 165g
 Protection PVC anti-reflets
 Conditionnement unitaire
 Couleur: aluminium
 (autres couleurs RAL, nous consulter)

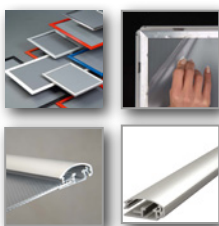

Réf	Format	Poids
AFV03-A1	A1	320g
AFV03-70x100	70x100cm	380g



Réf	Format	Poids
AFM03-A4	A4	580g
AFM03-A3	A3	910g
AFM03-A2	A2	1,4kg
AFM03-50x70	50x70cm	2,1kg
AFM03-A1	A1	2,8kg
AFM03-60x80	60x80cm	2,8kg

CADRE SLIDE-IN SUSPENDU

> AFSU06

Cadre slide-in suspendu par 2 câbles.
 Modèle recto-verso
 Insertion latérale des affiches.
 2 feuilles PVC transparentes fournies
 Conditionnement unitaire



Réf	Format	Poids
AFSU06	A1	2,7kg



CADRE VITRINE

> AFV01

Cadre snapframe à adhésiver sur une vitrine, visible de l'intérieur comme de l'extérieur. Conditionnement unitaire.
 Profilé: 32 mm - Finition: aluminium



Réf	Format	Poids
AFV01-A2	A2	1,6kg
AFV01-A1	A1	2,6kg
AFV01-60x80	60x80cm	



BUREAU DELTA

> SIG

Porte-visuel bombé pour signalétique bureau
 Visuel facile à changer
 Livré avec vis et adhésif au dos
 Conditionnement unitaire



Réf	Format	Poids
SIG01	4x15cm	50g
SIG02	20x8cm	220g
SIG03	15x15cm	300g
SIG04	15x21cm	530g
SIG05	21x29,7cm	980g
SIG06	30x42cm	1,5kg
SIG07	8x15cm	80g



BUREAU ÉCO

> SIG08

Cadre snapframe pour porte-visuel
 facile à changer
 Livré avec adhésif au dos
 Conditionnement unitaire

Réf	Format	Poids
SIG08S	15x10cm	110g
SIG08L	21x15cm	180g
SIG08XL	29x21cm	280g

> INFOBOARD

Présentoir de visuel et/ou brochures sur pied
 Mât en aluminium. Cadre snapframe
 Porte-brochures plexiglas
 Profondeur du bac: 40 mm
 Conditionnement individuel

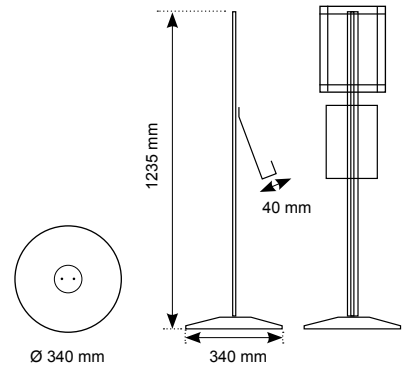

Réf		Poids
INFOBOARD01	Cadre A4 paysage + porte-brochures A4	4,6kg
INFOBOARD02	Cadre A4 portrait + porte-brochures A4	4,6kg
INFOBOARD03	2 cadres A4 paysage	4,7kg
INFOBOARD04	2 cadres A4 portrait	4,7kg
INFOBOARD05	3 cadres A4 paysage	5,4kg
INFOBOARD06	2 cadres A3 paysage	6kg



GMP STYLE > PV12

Élégant présentoir de visuel
Structure en aluminium et plexiglas
Facile à transporter
Conditionnement unitaire
Marquage de votre logo en option



Réf	Poids
PV12	6,4kg

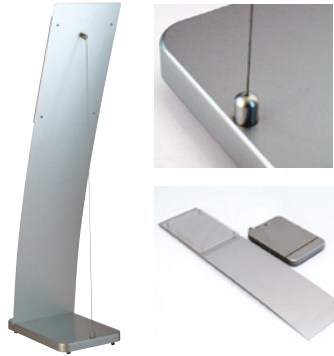

CADRE SUR PIED > AFS19

Cadre aluminium snapframe.
Idéal pour les expositions.
Hauteur réglable de 70 à 110 cm.
Profilé 25 mm. Couleur: aluminium
Conditionnement unitaire



Cadre pivotant!

Réf	Format	Poids
AFS190-SUZ	A4	3,2kg
AFS19-SUZ	A3	3,5kg

FORMAT
A4 ou A3

Réglable de 70 à 110 cm

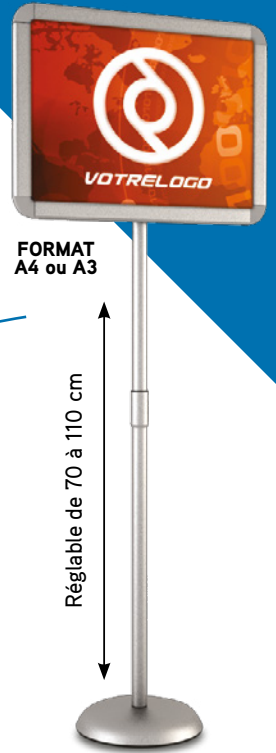

> MBR SET

Un design classique (A4 ou A3)
avec coins droits.
Nouveau mécanisme permettant
à la fois le format portrait et paysage.
Inox 7mm d'épaisseur avec base
en aluminium brossé.
Livré à plat.



Réf	Format	Poids
MBR SET	A4	4kg
MBR SET	A3	5kg



GMP ECO > GBS-P-342

Présentoir de visuel en aluminium
Porte-visuel A4 plexiglas
Dimensions: L.25xH.114xP.30,5 cm
Conditionnement unitaire

En option: marquage de votre logo

Réf	Poids
GBS-P-342	3,1kg

CADRE SLIDE-IN SUR PIED > AFSU06-SOL

Porte-visuel économique
réalisé en aluminium
Affichage recto-verso
Visuel protégé par 2 plaques PVC
transparentes anti-reflets
Cadre slide-in
Couleur: noir
Conditionnement unitaire

Réf	Dimensions	Poids
AFSU06-50x70-SOL	L.67,2xP.38xH.163cm	5,2kg
AFSU06-60x140-SOL	L.57,2xP.38xH.163cm	7,4kg



AFSU06-60x140



AFSU06-50x70





PORTE-BROCHURES ZIG-ZAG > SI25

Structure aluminium pliable
6 bacs plexi A4. Couleur argent
Livré avec sa valisette de transport
Conditionnement unitaire



Réf	Poids
SI25	5kg



SI26 SI27

PORTE-BROCHURES NYLON > SI26 / SI27

Structure snapframe haut et bas
Très léger et économique
Format de documents: A4
Hauteur: 138 cm
Conditionnement unitaire
Livré avec sa housse de transport

Réf	Poids
SI26	1,3kg
SI27	1,6kg



PB600

Structure en aluminium
3 porte-brochures plexi A4
Aussi léger que son prix!
Facilement transportable
grâce à ses pieds pliables
Hauteur: 136 cm
Conditionnement unitaire
Sac de transport en option.

Réf	Poids
PB600	5kg
PB600V	5kg



PORTE-BROCHURES POCKET > SI2500

Structure aluminium pliable
4 bacs plexi A4
Base: L26xP28 cm. Hauteur: 150 cm
Couleur argent
Livré avec son sac de transport
Conditionnement unitaire

Réf	Poids
SI2500	6kg



PB600

PB600V



GMP2 BROCHURES > PBV12

Élégant présentoir de brochures.
Réalisé en aluminium et plexiglas
Compartiments: 6 bacs A4 plexiglas
Facile à transporter
Conditionnement unitaire

Marquage en option

Réf	Poids
PBV12	12kg



PRÉSENTOIR PYRAMIDE > PB17

Présentoir de brochures alu et plexi
6 porte-brochures plexi format A4
Fronton personnalisable
Modèle recto-verso
Conditionnement unitaire

Réf	Poids
PB17	6,7kg

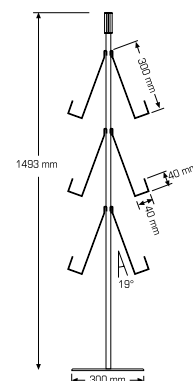



Fourche télescopique amovible pour une utilisation sur comptoir

PORTE-CARTES TÉLÉPHONIQUES

> PBV14
Présentoir métal 6 faces
Hauteur réglable entre 83 et 185cm
30 broches (long.25mm) fournies
Couleur noire
Double utilisation
Modèle de sol ou de comptoir



ÉTAGÈRE PLIABLE

> SI28
Étagère 4 niveaux fournie avec 16 plaques en PVC transparent
Éclairage par plafonnier - Livrée avec sa valise de transport
Facilement démontable et transportable
Hauteur: 192cm / Diamètre: 45cm
En option: marquage quadri haut et bas

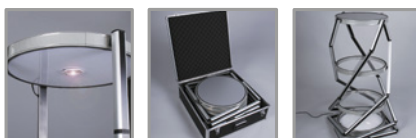

ÉTAGÈRE PRODUITS

> PPR37
Présentoir économique réalisé en PVC
Kit à monter
Conditionnement unitaire
Entièrement personnalisable

Réf	Poids
PPR37	11kg



WIROS ÉCO

Structure auto-portante en aluminium
6x cadres A4 R/V
Installation facile et sans pose
Version non rétro-éclairé du Wiros Lux
Poids net: 5,8 kg
Poids brut: 7,5 kg
Dimensions
L.81xH.200xP.1cm



*Idéal pour les
agences de voyage,
concessionnaires, etc...*



PUPITRE CLASSEUR

> PU03
Pupitre classeur sur pied
Format document: 2xA4
Dimensions: L.460xH.1000xP.320mm



ALUMINIUM STAND

> PB07
Structure en aluminium. Bac plexiglas A4
Dimensions de la structure: L.25xH.100 cm
Dimensions du pied: L.25 x P.33 cm
Poids: 7,5kg



CENTRO SHOWCASE®

> SI42

Vitrine démontable sécurisée à l'aide de plaques PVC transparentes
 Idéale salons & expositions
 Livrée avec 4 étagères en verre
 En option : habillage adhésif quadri haut & bas
 Poids : 30,5 kg

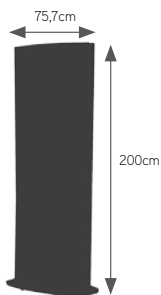

SLATWALL

> P_SLATWALL

Poids net : 26,3 kg // Poids brut : 29,5 kg
Dimensions : L.822xH.1800xP.45mm
 Accessoires en option
 (broches, porte-brochures etc.)

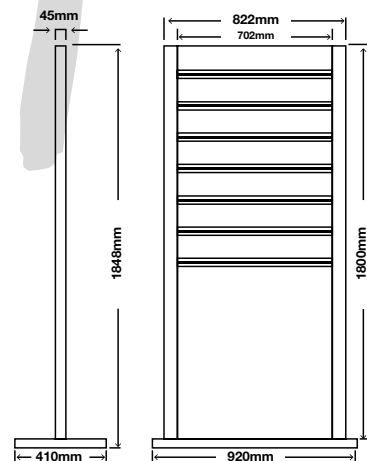
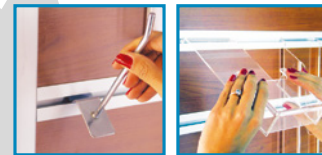

CENTRO CONSOLE®

> SI41

Vitrine démontable
 Livrée avec 4 étagères en verre
 Idéale pour salons & expositions
 En option : habillage adhésif quadri haut & bas
 Poids : 31 kg

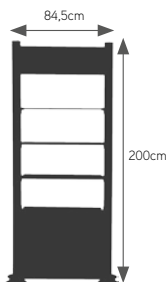

COMBO

> P_COMBO

Poids net : 26,3 kg
 Poids brut : 29,5 kg
Dimensions : L.820xH.1800xP.45mm
 1x cadre 25mm (A1)
 4x porte-brochures (11x21cm)
 ou 2x porte-brochures A4

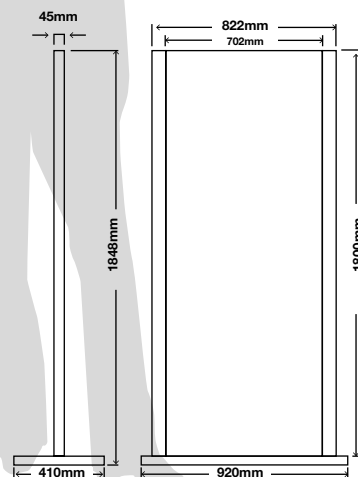
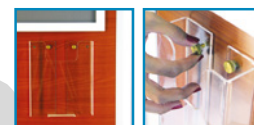

CENTRO CONSOLE® BIG

> SI41 BIG

Modèle identique au SI41 (ci-dessus)
 avec 2 kakémonos 60x160 en plus
 Poids : 34kg





en option
Visuel quadri
aimanté

**COLONNE
VITRINE PRODUIT**

Base métallique couleur blanc
En option : personnalisation visuel magnet quadri
Caisson plexiglas L.50xP.50xH.130cm
Hors-tout L.50xP.50xH.130cm



VITRINE VI06

Vitrine murale en verre trempé
Portes vitrées 5mm coulissantes à serrure
L.100xH.100xP.20cm



VITRINE VI03

Structure aluminium haute qualité
Portes vitrées coulissantes à serrure
Roulettes auto-bloquantes
L.100xH.100xP.50cm

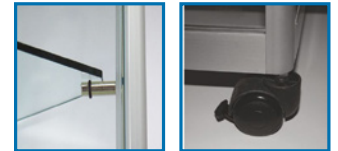

VITRINE VI01

Vitrine en verre Securit
Roulettes auto-bloquantes
Structure à assembler
L.50xP.50xH.200cm
Poids : 50kg



en option
Marquage
quadri

VITRINE VI02

Vitrine en verre trempé
Roulettes auto-bloquantes
Etagères 6mm d'épaisseur
L.50xP.50xH.200cm



en option
Marquage
quadri

VITRINE VI05

Vitrine en verre trempé
Roulettes auto-bloquantes
Etagères 8mm d'épaisseur
L.95xP.50xH.200cm



VITRINE VI04

Vitrine pliable
Transport et stockage facile
Structure à assembler
L.50xP.50xH.200cm

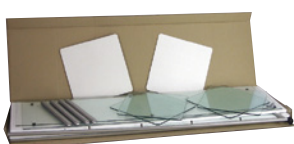

DELTA FOOT

Design moderne pour ce porte-visuel courbé recto-verso
Structure aluminium solide et durable avec une finition argentée
Idéal pour les zones de forte affluence (halls d'exposition, boutiques, hôtels, ...)

Impressions quadri sur papier couché en recto-verso
Format des visuels 500x1400mm (500x700mm pour le Delta Foot Demi)

Dimensions L.500xH.1735mm



DELTA FOOT DEMI



INFO POSTER

>PV14

Élégant porte-visuel aluminium
Hauteur 174cm

FORMATS D'AFFICHAGE DISPONIBLES

500x700mm	A1 (594x841mm)
700x1000mm	



En option
> MODÈLE
RECTO-VERSO

à partir de

129,00€

PORTE-BROCHURES MULTI-FORMATS

> PB34

Structure métal rainurée
Multi-bacs plexiglas personnalisables
Marquage en option

Réf	Cond.	Poids
PP34	1	N.C.

Porte-brochures A4 et 1/3 A4 en option
Système de fixation inclus

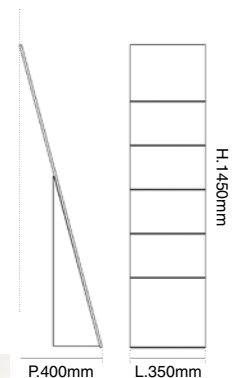

PORTE BROCHURES



PB30

PB28 BIS

PB28BIS

Grande capacité
8xA4 (recto) ou 16xA4 (recto-verso)
Fronton snapframe intégré
Dimensions : L.535 x H.1910mm
Conditionnement unitaire

PB30

Très grande capacité
16xA4 (recto) ou 32xA4 (recto-verso)
Dimensions : L.950 x H.1770mm
Conditionnement unitaire



MONOLITH STAND

> PBV15

Présentoir métal & aluminium

En option :

- Porte-brochures A4 ou 1/3 A4

- Modèle recto-verso

FORMATS D'AFFICHAGE

A2 (420x594mm)	500x700mm
A1 (594x841mm)	700x1000mm

PORTE-BROCHURES

> PBV04



Réf	Poids
PBV04	15,5kg

Présentoir de brochures métal
Porte-visuel A4 servant de fronton
Équipé de roulettes. Protection PET anti-pluie
Couleur : noir
Conditionnement unitaire

Autres coloris sur demande : nous consulter

COLONNES PORTE-BROCHURES



Finition aluminium
Facilement démontable

Personnalisation possible :
nous consulter

2 versions disponibles

PB31 (2 faces)
10x porte-brochures A4

PB32 (4 faces)
20x porte-brochures A4
4 roulettes avec frein

Réf	Version	Poids	Logo en option
PB31	2 faces	9kg	N.C.
PB32	4 faces	13kg	N.C.

TOTEM AIMANTÉ

2 tailles disponibles

Double face

Version intérieure ou extérieure

Personnalisation facile & rapide

Réf	Format
TOT_AIM 500	500x1600mm
TOT_AIM 800	500x1800mm

VISUEL AIMANTÉ
REPOSITIONNABLE

PROFILÉ
EXTRA-FIN

CHOISISSEZ VOS ÉLÉMENTS ET
COMPOSEZ VOTRE
TOTEM MÉTAL



Porte-brochures	Urne jeu
Porte-visuel	Porte cartes de visite
Tablette porte-produits	Teinte du socle
Teinte de la structure	

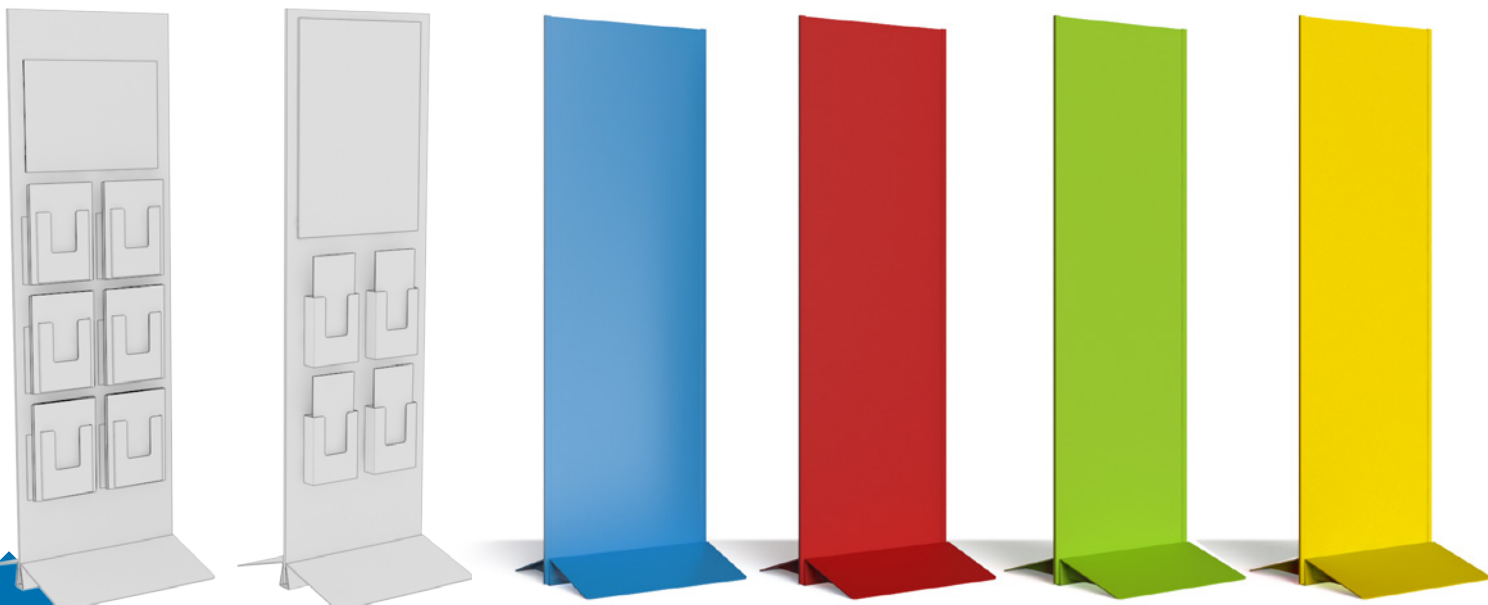

CADRES LED

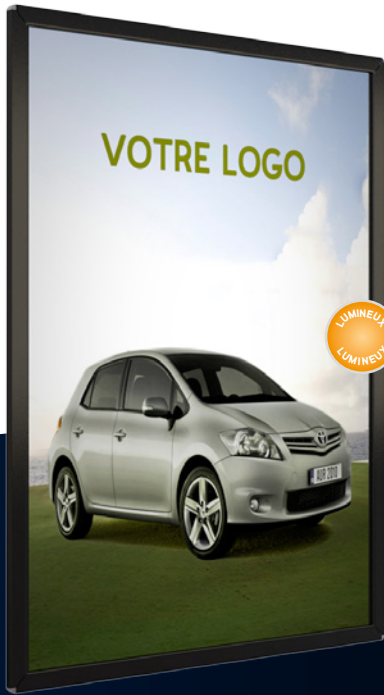

retro-éclairage LED!

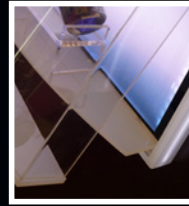
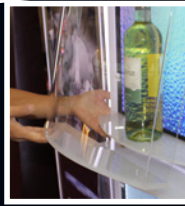

CAISSONS DESIGN MURAL

- Caisson mural porte-produits
- Retro-éclairage LED
- Ouverture facile
- 2 modèles disponibles
- Impression visuel backlight*

*(en option sur demande)

Réf	Dimensions	Poids produit/ emballage
CDM01	H.612xL.412mm	6kg/8kg
CDM02	H.385xL.412mm	4,5kg/6kg

CADRE LED SUSPENDU

- Cadre suspendu LED
- Aluminium haute-qualité
- Affichage double-face



PROFILÉ 40mm ÉPAISSEUR 31mm

CADRE LED MURAL

- Cadre LED mural
- Système snapframe
- Lumière douce et économique

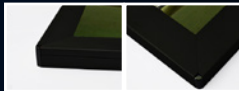

PROFILÉ 25mm ÉPAISSEUR 16mm

Réf	Dimension structure	Format d'affichage	Poids
AFLED_A3R	H.480xL.357xP.16mm	A3	1kg
AFLED_A2R	H.654xL.480xP.16mm	A2	2kg
AFLED_A1R	H.901xL.654xP.16mm	A1	3,5kg

Réf	Dimension structure	Dimension d'affichage	Poids
AFLED_A1RV	H.891xL.644xP.31mm	A1	7kg

MINI TOTEM BACKLIGHT

> MINI_TOT_BACK

Totem élégant sur pied rétro-éclairé de face
Format 20x100 cm



Marquage quadri en option!



MOBILE LIGHT

- Cadre LED sur pied
- Affichage double-face
- 4 roulettes intégrées
- Utilisation en intérieur
- Très forte luminosité

4 roulettes intégrées!



Réf	Dimensions structure	Dimensions d'affichage	Poids
MOBILE_LIGHT_IND	H.900xL.600xP.35mm	500x800mm	28,6kg

TOTEMS RÉTRO-ÉCLAIRÉS

- Colonne rétro-éclairée double-face
- Structure aluminium
- Socle acier RAL 9006
- Panneaux PVC anti-reflets
- Système de fixation snapframe
- Conditionnement individuel



Réf	Format des visuels	Poids
AFS13-1	594x1680mm	26,5kg
AFS13-2	700x2000mm	30,5kg
AFS13-PB	594x841mm	27,5



AFS13-1

AFS13-2

AFS13-PB

WIROS LUX

Porte-affiches led auto-portant

Marquage fronton recto verso inclus !

- Structures auto-portantes en aluminium
- Documents A4 standards ou diffusants
- Faible consommation électrique
- Durée de vie de 60.000 heures
- Seulement 12 mm d'épaisseur
- Installation facile et sans pose
- Excellent rapport qualité prix
- Garantie 1 an



6x44 portrait

8x44 paysage



CRISTAL LIGHT BOX

- Cadres LED cristal sur pied
- Affichage double-face
- Utilisation intérieure
- 2 modèles disponibles



CRISTAL LARGE

CRISTAL SMALL



Réf	Dimensions	Poids produit/ emballage
CRISTAL_SMALL	H.1650xL.450xP.14mm	25kg/35kg
CRISTAL_LARGE	H.1800xL.700xP.16mm	40kg/55kg

CADRE MURAL



CADRE SUR PIEDS

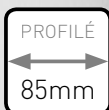
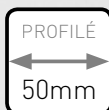

CADRE SUSPENDU

EN OPTION
TROLLEY
DE TRANSPORT
SUR ROULETTES



CADRES *TISSU TENDU*

Cadres aluminium pour visuel textile facilement démontable grâce à un système de connecteurs. Léger, compact, facile à installer et à transporter, chaque cadre est livré en kit avec impression textile (quadri en sublimation)

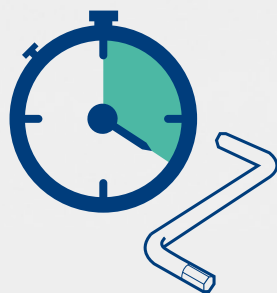

INSTALLATION FACILE & RAPIDE
une clé Allen (fournie) suffit!

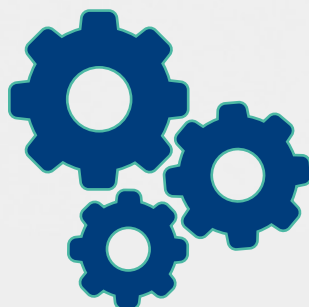

DIMENSIONS SUR MESURE
Tous formats disponibles

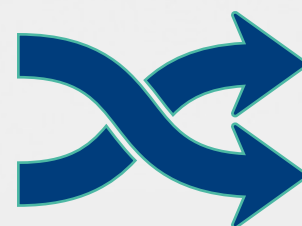

CHANGEMENT DE VISUEL FACILE
en quelques secondes

CADRES TISSU **RÉTRO ÉCLAIRÉS**



PROFILÉ
←→
85mm

DOUBLE
FACE

- Eclairage LED
- Modèle sur pieds

Assurez une visibilité optimale
dans vos points de vente
et salons d'exposition !



DIMENSIONS
SUR MESURE

Tous formats disponibles

CADRES TISSU **SUR PIEDS**

CADRES TISSU



FORMAT
1000x2400mm

1x SPOT LED
EN OPTION



FORMAT
2000x2400mm

2x SPOT LED
EN OPTION



FORMAT
3000x2400mm

1x SPOT LED
EN OPTION

EN OPTION

**IMPRESSION
VERSO**



**TROLLEY
DE TRANSPORT
SUR ROULETTES**

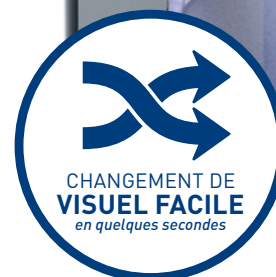

**CHANGEMENT DE
VISUEL FACILE**
en quelques secondes

PACKS CADRES TISSU

STANDS D'EXPOSITION MODULAIRES



INSTALLATION
FACILE & RAPIDE



INNOVANT &
IMPACTANT



MODULABLE &
RECONFIGURABLE



ÉCONOMIQUE



PACK 01

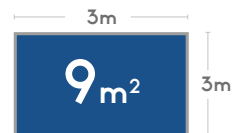

PACK 02

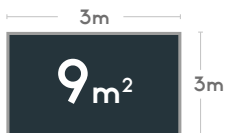

TEMPS
DE MONTAGE
2H

PACK 03

4m
12m²
 3m



TEMPS
DE MONTAGE
2H30



PACK 04

6m
18m²
 3m



TEMPS
DE MONTAGE
2H30



PACK 05

6m
18m²
 3m



TEMPS
DE MONTAGE
3H



PACK 06



PACK 07



PACK 08

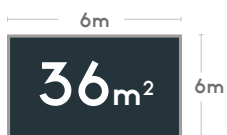

TENSION FABRIC

Nouvelle solution tubulaire
Légère & facile à transporter
Impression quadri en sublimation
Système de fermeture éclair
Livré avec son sac de transport

TENSION FABRIC



SAC DE
TRANSPORT



SPOT
LED



SYSTÈME DE
FIXATION



FERMETURE
ECLAIR



FABRIC POP UP COURBE

> SI30 / SI30_MINI

Version courbe
Très forte dégressivité selon quantité
(à partir de 270 euros HT pour 100 ex)



FABRIC POP UP DROIT

> SI30_DROIT



FABRIC POP UP WAVE

> SI30_VAGUE

STAND PARAPLUIE PVC COURBE

Fourni avec
Structure + Visuel + Trolley !



**VERSION
RECTO-VERSO**
SI21-RV

- > VISUEL AIMANTÉ SUR UNE STRUCTURE MAGNÉTIQUE
- > IMPRESSION QUADRI NUMÉRIQUE HAUTE-DÉFINITION
- > PLASTIFICATION MAT 75µ
- > IMPRESSION ET PLASTIFICATION M1 ANTI-FEU



**TROLLEY
DE TRANSPORT
+ SPOTS
INCLUS**

EN OPTION



**TABLETTE ET
HABILLAGE**

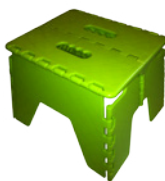

TABOURET



**ÉCRAN 15"
+ KIT DE
FIXATION**

Réf	Poids	Habillage trolley	Tablette trolley
SI21-2x3-ECO*	-	Non dispo	Non dispo
SI21-2x3	24kg	Non dispo	Non dispo
SI21-3x3	33kg	oui	oui
SI21-4x3	36kg	oui	oui
SI21-2x3-RV	29kg	oui	oui
SI21-3x3-RV	39kg	oui	oui
SI21-MINI-3x3	-	Non dispo	Non dispo
SI21-MINI-3x3-RV	-	Non dispo	Non dispo

*Fourni sans spot et avec un trolley tissu

STAND PARAPLUIE PVC DROIT



**VERSION
RECTO-VERSO**
SI21-DROIT-RV

Réf	Poids	Habillage trolley	Tablette trolley
SI21-DROIT- 2X3-ECO*	-	Non dispo	Non dispo
SI21-DROIT-2x3	24kg	Non dispo	Non dispo
SI21-DROIT-3x3	33kg	oui	oui
SI21-DROIT-2x3-RV	29kg	oui	oui

*Fourni sans spot et avec un trolley tissu

TROLLEYS DE TRANSPORT

TROLLEY 1

Caisson trolley petit modèle

Dimensions hors-tout	H.95xL.38xP.41cm
Dimensions intérieures	H.90xL.37xP.39cm
Contenance	0,13m ³
Poids à vide	8kg



TROLLEY TISSU POUR STRUCTURE CENTRO

Trolley de transport sur roulettes

Dimensions hors-tout	H.119xL.23xP.50cm
Dimensions intérieures	H.116xL.20xP.47,5cm
Contenance	0,11m ³
Poids à vide	8kg



TROLLEY 2

Caisson trolley grand modèle

Dimensions hors-tout	H.99xL.68xP.37,5cm
Dimensions intérieures	H.90xL.37xP.39cm
Contenance	0,22m ³
Poids à vide	13kg



TUBE TISSU POUR VISUEL

Trolley tissu pour transport de visuels

Dimensions hors-tout	H.102xH. diam25cm
Dimensions intérieures	H.101xH. diam19cm
Contenance	N.D.
Poids à vide	2kg



TROLLEY CUSTOMISÉ

Caisson trolley grand modèle avec tablette et habillage

Dimensions hors-tout	H.99xL.68xP.37,5cm
Dimensions intérieures	H.90xL.37xP.39cm
Contenance	0,22m ³
Poids à vide	15kg



TROLLEY TISSU

Trolley tissu pour stands textiles

Dimensions hors-tout	H.80xL.41xP.41cm
Dimensions intérieures	H.80xL.37xP.37cm
Contenance	0,11m ³
Poids à vide	4kg



STANDS PARAPLUIE PVC GRAND FORMATS

GARANTIE
10 ANS

- > COMBINAISON DE 2 STANDS PARAPLUIE COURBE
- > CHAQUE VERSION EST DISPONIBLE EN 3 TAILLES
- > MONTABLE & DÉMONTABLE EN 20 MINUTES

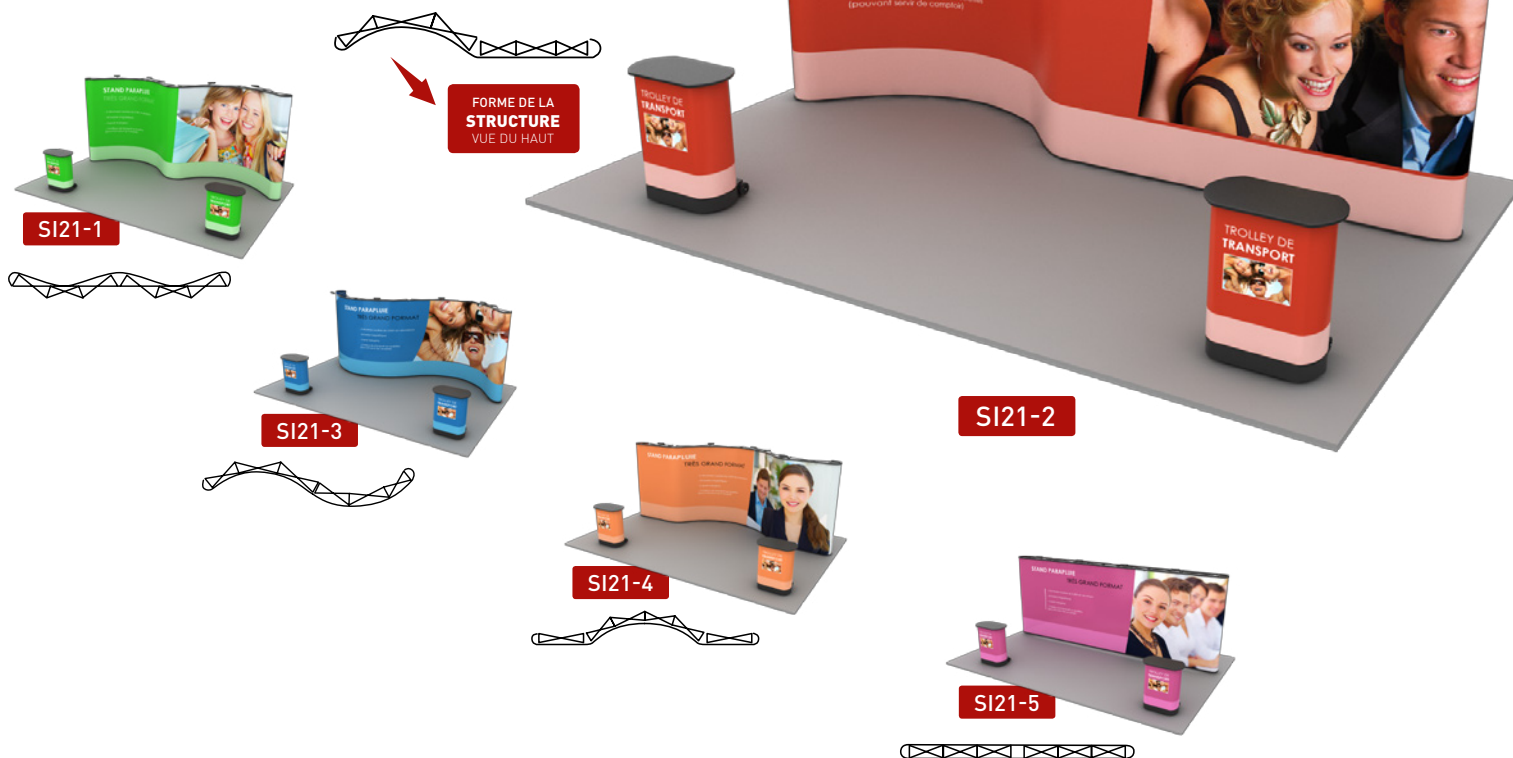

ADJUSTABLE FRAME

>SI24



*Largeur et hauteur
réglables !*

Structure aluminium et acier
Dimensions : L.147-315xH.107-247cm
Grande base en acier pour une bonne stabilité

STAND ARAIGNÉE

>SI29



SAC DE
TRANSPORT
FOURNI

*Structure et
impression inclus !*

Structure composée de 5 parties
Impression quadri en sublimation
Livré avec son trolley de transport



STANDS PARAPLUIE TISSU

- > IMPRESSION QUADRI EN **SUBLIMATION**
- > SUPPORT FIXÉ PAR **BANDES VELCROS**
- > MONTABLE & DÉMONTABLE EN **20 MINUTES**
- > LIVRÉ AVEC **2 SPOTS + TROLLEY DE TRANSPORT**



TISSU DROIT

>SI20-DROIT

Réf	Poids
SI20-2x3	11kg
SI20-3x3	13,5kg
SI20-4x3	16,0kg
SI20-2x3-RV	13,5kg
SI20-3x3-RV	15,5kg
SI20-4x3-RV	19,0kg



**VERSION
RECTO-VERSO**
SI20-RV



Version Recto-Verso disponible !

TISSU COURBE

>SI20-COURBE

Réf	Format	Poids
SI20-A-COURBE	3x3	13,5kg
SI20-B-COURBE	4x3	16,0kg
SI20-A-COURBE-RV	3x3	15,5kg
SI20-B-COURBE-RV	4x3	19,0kg



DROIT GRAND FORMAT

>SI20-GRAND-FORMAT

Réf	Recto	Recto Verso
SI20-GRAND-FORMAT-5x3	oui	oui
SI20-GRAND-FORMAT-6x3	oui	oui
SI20-GRAND-FORMAT-7x3	oui	oui
SI20-GRAND-FORMAT-8x3	oui	oui

**SPOT
EN OPTION**
NOUS CONSULTER

PACKS PROMO



PACK **GOODDEAL**

1x Pop Comptoir SI3300
2x Roll-up SI14 (84x207cm)
1x Porte-brochures SI27



PACK **SUBLIM**

1x Stand Parapluie Tissu SI20-3x3
2x Roll-up SI14 (84x207cm)
1x Comptoir textile SI31



PACK **CRAZY**

1x Stand Parapluie Tissu SI20-3x3
2x Roll-up SI14 (84x207cm)
1x Comptoir SI34
1x Porte-brochures PB600



PACK **PRIVILEGE**

1x Stand Parapluie SI21-3x3
2x Roll-up SI14 (84x207cm)
1x Trolley de transport customisé

PACK **VIDEO FLYER**

- 1x Totem Flyer 19"
- 1x Roll-up S114 (84x207cm)
- 1x Comptoir SI34



PACK **VIDEO FLYER PREMIUM**

- 1x Stand Parapluie PVC SI21-3x3
- 1x Trolley de transport customisé
- 1x Totem Flyer 19"
- 1x Roll-up SI13 (80x205cm)

PACK **FULL HD**

- 1x Stand Parapluie Tissu SI20-3x3
- 1x Comptoir textile SI31
- 1x Totem LCD 42" Vertical
- 1x Porte-brochures PB28



PACK **TACTILE**

- 1x Stand Parapluie SI21-2x3
- 1x Roll-up SI13 (80x205cm)
- 1x Comptoir SI32
- 1x Borne Tactile 22"

ROLL-UP

Découvrez notre gamme d'enrouleurs livrés avec visuel quadri haute-définition et sac de transport

INCLUS

**VISUEL HD
QUADRI**

**SAC DE
TRANSPORT**

**GARANTIE
10 ANS**



ROLL-UP INITIAL > SI14

Ref	Poids avec sac
SI14-65x207cm	3,9kg
SI14-84x207cm	4,2kg
SI14-100x207cm	4,6kg
SI14-120x207cm	6kg
SI14-150x207cm	6,7kg

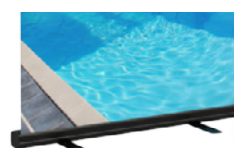

**DISPONIBLE
EN NOIR**



ROLL-UP PREMIUM > SI13

Ref	Poids avec sac
SI13-80x205cm	5,1kg
SI13-100x205cm	6,2kg
SI13-120x205cm	7,4kg
SI13-150x205cm	8,6kg
SPOT EN OPTION	



ROLL-UP TÉLESCOPIQUE SNAPFRAME > SI12

Ref	Poids avec sac
SI12-80x205cm	7,5kg
SI12-100x205cm	8,5kg

**HAUTEUR
RÉGLABLE**



ROLL-UP
**INITIAL
DOUBLE**
> SI15

Réf	Poids avec sac
SI15-80x205cm	7,5kg



ROLL-UP
**TÉLESCOPIQUE
DOUBLE
SNAPFRAME**
> SI16

Réf	Poids avec sac
SI16-80x205cm	7,5kg
SI16-100x205cm	8,5kg



ROLL-UP
XXL
> SI-XXL



Réf	Poids avec sac
SI-XXL-200x224cm	11kg
SI-XXL-240x224cm	12,5kg



/ VUE DE DOS

BANNERS ALU

X-BANNER

>S108



X-BANNER
BIG
> S108-BIG

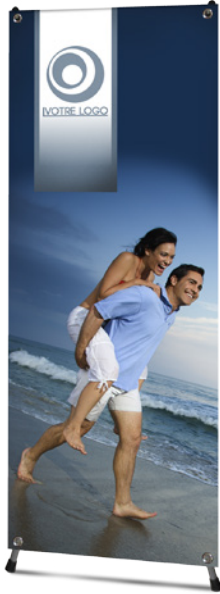

X-BANNER
SMALL
> S108-SMALL

L'affichage léger & économique !
Structure en aluminium ultra légère
Impression sur bâche avec oeillets

2 FORMATS

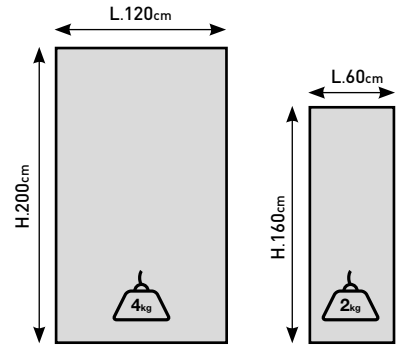
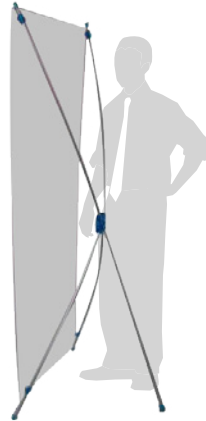

BANNER

SNAPFRAME

>S102

Fixation snapframe haut et bas
Changement facile & rapide du visuel

TOUS NOS BANNERS
SONT LIVRÉS AVEC
VISUEL IMPRIMÉ
+
SAC DE TRANSPORT

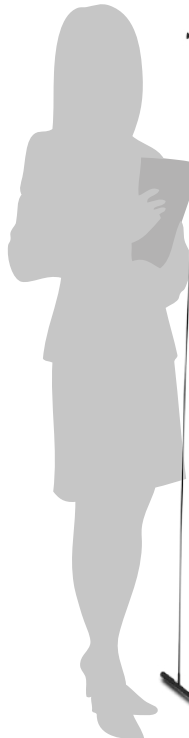
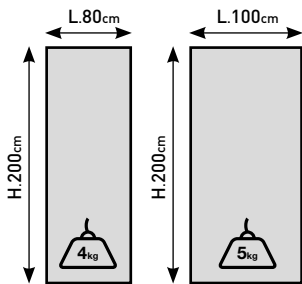

BANNER

L-BANNER

>S101

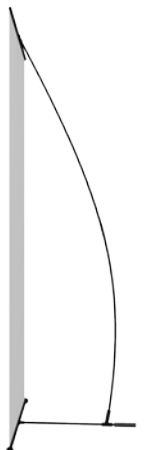
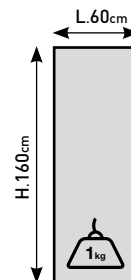

DOUBLE BANNER SNAPFRAME

>SI09 Fixation snapframe haut et bas
Changement facile & rapide du visuel

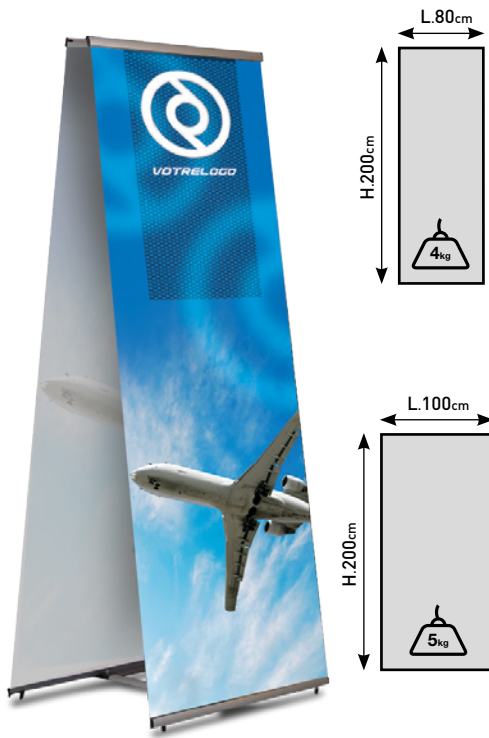

DOUBLE BANNER SMALL

>SI10

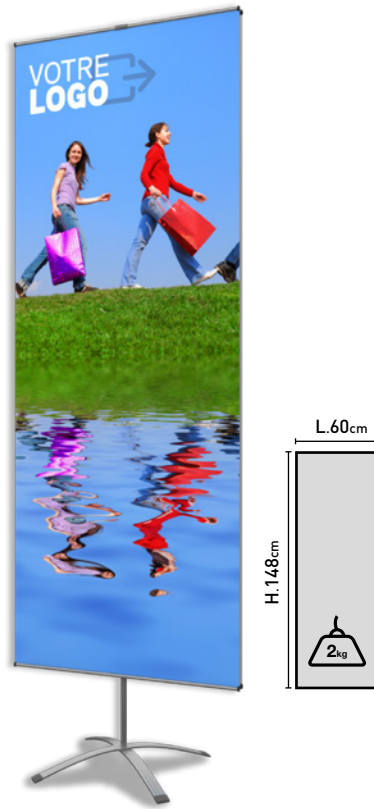

DOUBLE BANNER BIG

>SI10-BIG

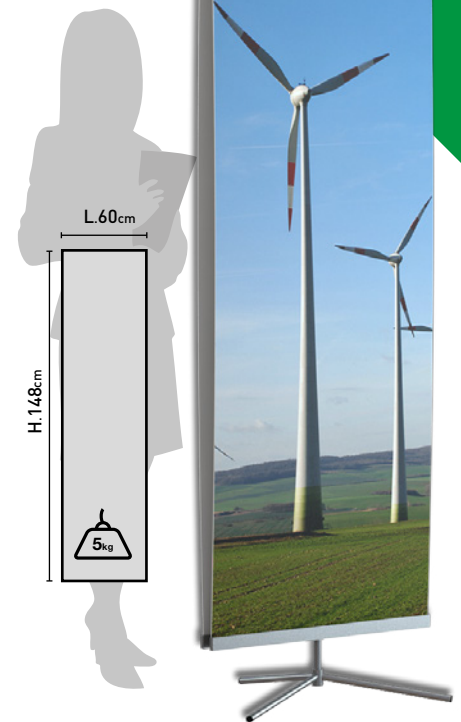

BANNER TRIPTYQUE

>SI11

3 FACES



TOTEM TOWER

>SI40

Structure cylindrique en aluminium
Visuel aimanté sur structure magnétique





COMPTOIR POP-UP

>SI3300

Structure en aluminium
Impression quadri numérique haute-définition
Visuel PVC 450µ avec plastification
Traitement anti-rayures et anti-reflets
Visuel aimanté sur structure magnétique
Étagères amovibles intégrées
Livré avec son plateau noir (blanc en option)

VISUEL AIMANTÉ
CHANGEMENT
FACILE & RAPIDE

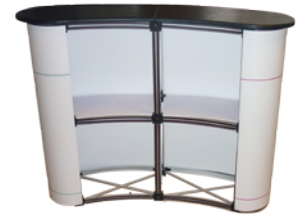
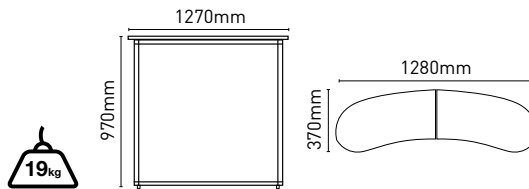

COMPTOIR DROIT

>SI33-BIS

Structure en aluminium et PVC
Impression quadri numérique haute-définition
Visuel vinyle adhésif contre-collé sur PVC
Étagère amovible intégrée
Livré avec un plateau blanc
Sac de transport inclus

PLATEAU DISPO EN
2 COLORIS



ÉTAGÈRE AMOVBLE
INTÉGRÉE

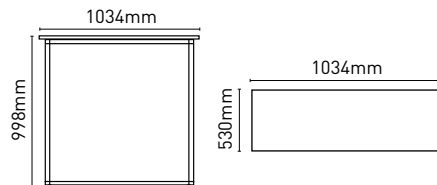

COMPTOIR EASY

>SI34

Structure en aluminium
Impression quadri numérique haute-définition
Visuel vinyle adhésif contre-collé sur PVC
Traitement anti-rayures et anti-reflets
Étagère amovible intégrée
Livré avec un plateau blanc
Sac de transport inclus

ÉTAGÈRE AMOVBLE
INTÉGRÉE

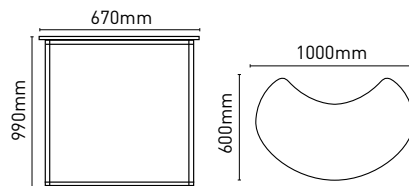

TROLLEY CUSTOM

Trolley de transport rotomoulé sur roulettes
Impression quadri numérique haute-définition
Visuel PVC 450µ avec plastification
Traitement anti-rayures et anti-reflets
Visuel aimanté sur structure magnétique

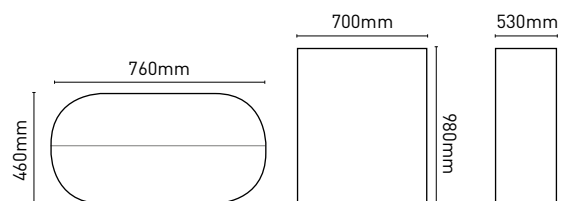

TABLETTE

FACE

PROFIL

COMPTOIR CONVEXE

>SI32

Structure en aluminium et PVC
Impression quadri numérique haute-définition
Visuel vinyle adhésif contre-collé sur PVC
Étagère amovible intégrée
Livré avec un plateau blanc
Sac de transport inclus

PLATEAU DISPO EN
2 COLORIS



VERSION DOUBLE

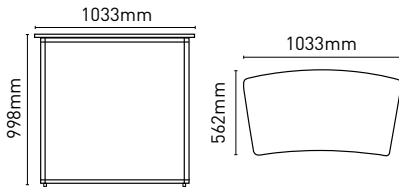

COMPTOIR MIXTE

>SI43

Comptoir d'accueil en matériaux composites
Livré avec son plateau finition bois
Porte-brochures aluminium inclus
Facilement montable et transportable
Clé Allen incluse
Kakemono imprimé quadri
Sac de transport inclus
Poids : 22kg

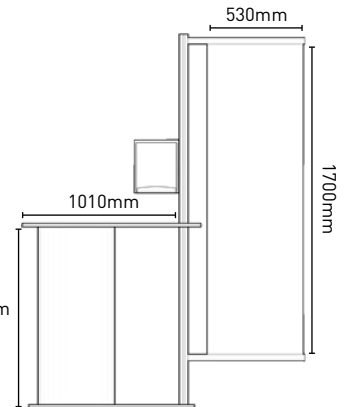
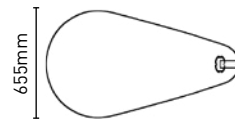

COMPTOIR PROMO

>SI36

Comptoir en PVC
Impression quadri numérique haute-définition
Visuel vinyle adhésif contre-collé sur PVC
Étagère fournie
Sac de transport inclus

ÉTAGÈRE
INTÉGRÉE

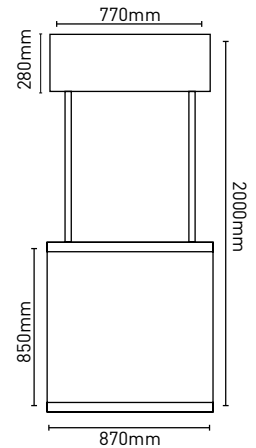
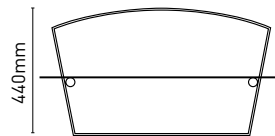

TROLLEY PROMO MB

>SI35

Comptoir en PVC
Impression quadri numérique haute-définition
Visuel vinyle adhésif contre-collé sur PVC
Étagère fournie
Sac de transport inclus

MONTÉ SUR
ROULETTES

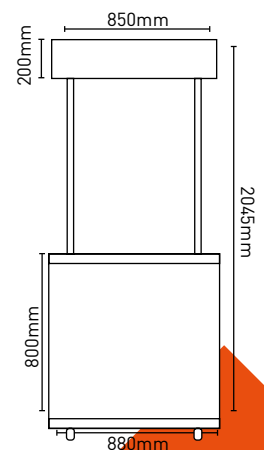
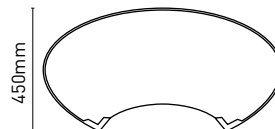



COMPTOIR SÉCURISÉ

>D2DZ90

Structure en aluminium
Impression quadri numérique haute-définition
Visuel vinyle adhésif contre-collé sur PVC
Étagère amovible intégrée
Porte arrière avec serrure et jeu de clés
Livré avec son plateau blanc (autres finitions dispo)
Sac de transport inclus

PORTE ARRIÈRE
AVEC SERRURE

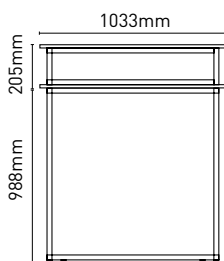

COMPTOIR CENTRO

Structure courbe en aluminium anodisé
Impression quadri numérique haute-définition
Visuel PVC 450µ avec plastification
Traitement anti-rayures et anti-reflets
Visuel aimanté sur structure magnétique
Étagère amovible intégrée

ÉTAGÈRE AMOVIBLE
INTÉGRÉE

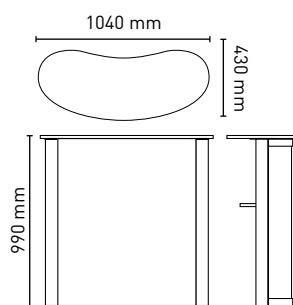

COMPTOIR TEXTILE

>SI31

Comptoir pop-up textile
Structure ultra-légère
Impression quadri sur tissu en sublimation
Plateau noir fourni

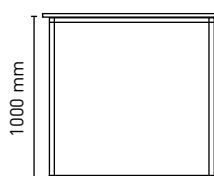
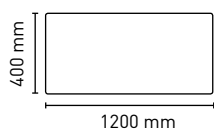

COMPTOIR PB

>SI37

Borne d'accueil dépliable
3 porte-brochures A4 intégrés
Livré avec son sac de transport

PORTE-BROCHURES
INTÉGRÉ



COMPTOIR GRAND FORMAT

>SI44

Comptoir grand format en aluminium et PVC
Visuel interchangeable imprimé en quadri
Installation facile avec fixation par velcros
Conditionnement en caisse bois

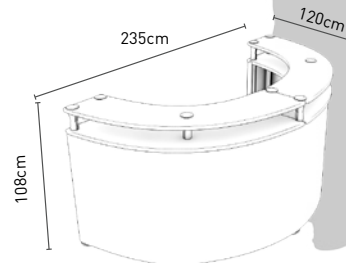

COMPTOIR TISSU

>SI45

Structure aluminium
Impression quadri sur tissu en sublimation
Porte arrière avec serrure et jeu de clés
Étagère amovible intégrée



COMPTOIR CARTON

Structure en carton alvéolaire
Adapté à tous les événements

**DIMENSIONS
SUR MESURE**
CONSULTEZ-NOUS !

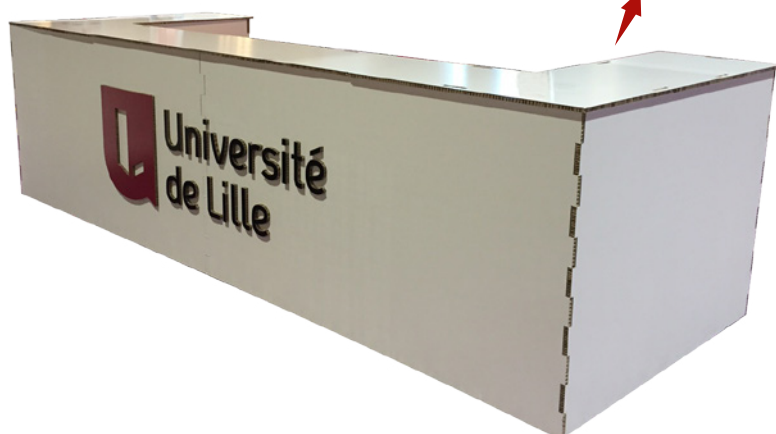

SIGNALÉTIQUE PLAFOND



BALLON PUBLICITAIRE

Ballon en polyuréthane avec marquage en impression numérique
Gonflé à l'air ou à l'hélium (gaz neutre ininflammable)
Équipé d'une valve avec clapet anti-retour
Livré avec une ligne de maintien de 30m + kit de réparation
Les ballons sont reliés par 8 points d'attaches

MARQUAGE
QUADRI
2 FACES

4 FACES
NOUS
CONSULTER

Ø180cm

Ø250cm

Ø300cm

CIRCLE ROOF

Structure tubulaire en aluminium facile à assembler
Impression quadri en sublimation à suspendre
Idéale en salon, percutante en point de vente !
2 tailles disponibles

Format	Dimensions structure	Dimensions visuel	Poids
Small	1524x762mm	4790x762mm	16kg
Medium	3048x610mm	9570x610mm	25kg



TEXTILE SUSPENDU

Cube ou rectangle textile suspendu
Nous nous adaptons au format que vous souhaitez afin de vous apporter une solution visible et percutante adaptée à toutes les surfaces de stand



STANDS MODULAIRES

CENTRO

CENTRO

Une solution simple, innovante et totalement modulable pour vos stands d'exposition

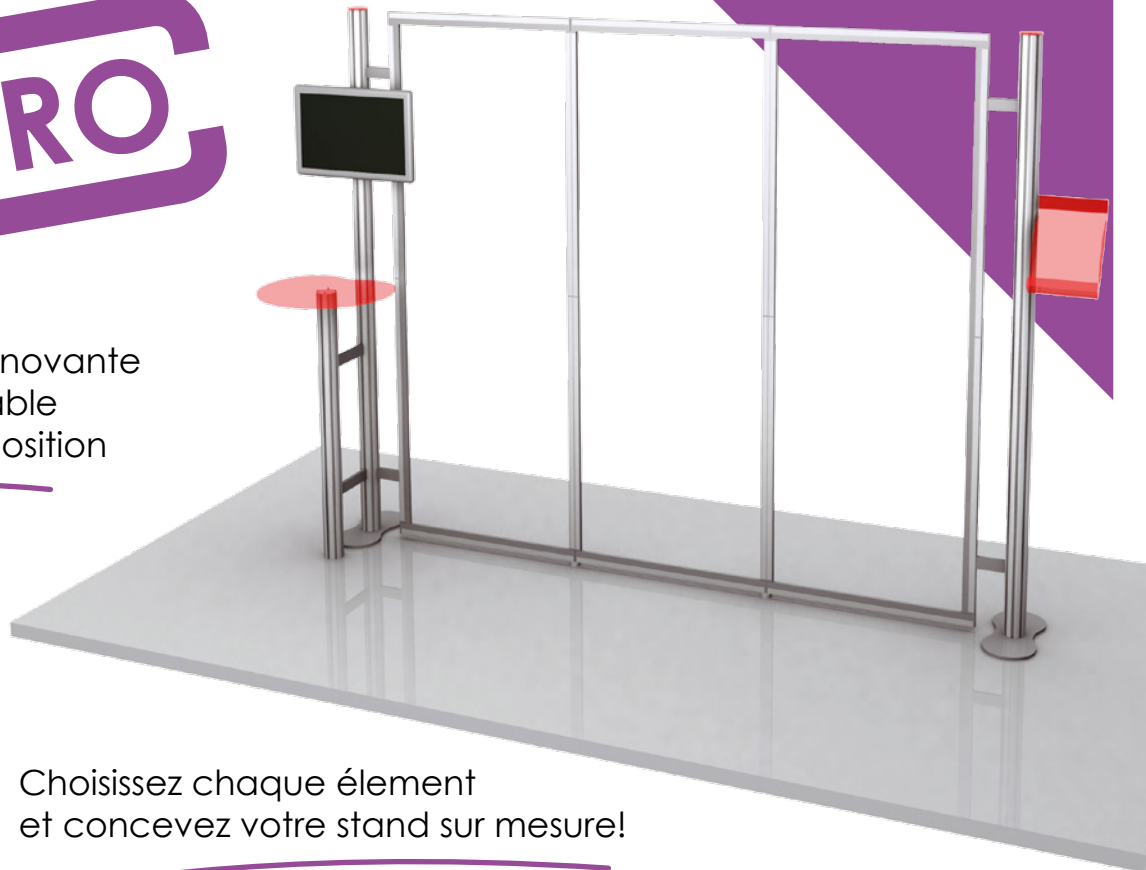

Choisissez chaque élément et concevez votre stand sur mesure!



Réserve
1x1m



Ecran LCD
avec système de fixation



Porte-brochures
plexiglas



Porte-brochures
métal



Tablette
porte-produit

Podium
plexiglas



T-LOCK[®]

FIXATION SANS OUTIL

MONTAGE FACILE & RAPIDE
FONCTION *TWIST & LOCK*

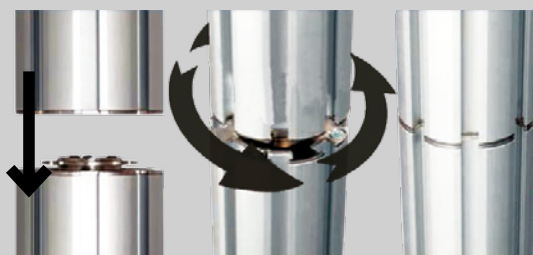
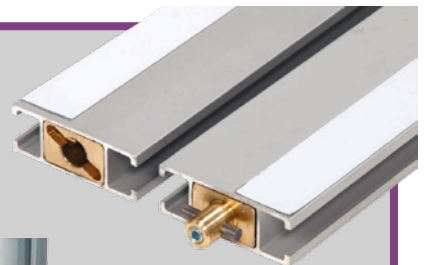

CENTRO WINDOW®

Système d'affichage modulaire innovant
 Structure monobloc robuste en aluminium anodisé
 Panneaux magnétiques pour un montage facile et rapide
 Platines métal pour une stabilité maximale
 Hauteur 2m - Visserie incluse



C1 1003x2014 mm	C2 1927x2014 mm	C3 2649x2014 mm	C4 3371x2014mm	C5 4083x2014 mm
CS1 1223x2014 mm	CS2 2367x2014 mm	CS3 3309x2014 mm	CS4 4251x2014mm	CS5 5193x2014 mm

CENTRO STRAIGHT®



CG2 1753x2014 mm	CG3 2503x2014 mm	CG4 3033x2014 mm
CGS2 1973x2014 mm	CGS3 2723x2014 mm	CGS4 3253x2014 mm

CENTRO CURVED®

Augmentez votre visibilité grâce aux rails incurvés!

INCLUS
STRUCTURE
VISUEL
SAC DE TRANSPORT



EXISTE AUSSI EN
240CM
DE HAUTEUR

CENTRO

DISPONIBLE
EN RECTO-VERSO

DISPONIBLE EN
3m
DE HAUTEUR

GARANTIE
10 ans
GARANTIE



CG2C 1800x2014 mm

CGS2C 2000x2014 mm



CG3C 2495x2014 mm

CGS3C 2665x2014 mm



CG4C 3170x2014 mm

CGS4C 3260x2014 mm

CENTRO THEATRE®



CT2
1756x2014mm

CT1
1206x2014mm



CT3
3254x2014mm

DISPONIBLE
EN RECTO-VERSO

DISPONIBLE EN
3m
DE HAUTEUR

GARANTIE
10 ans
GARANTIE

Choisissez votre écran TV !



Disponible également
en version sans écran

Sac + trolley de transport inclus



CENTRO PACKS

TOUT INCLUS

**STRUCTURE
+ VISUEL
+ TROLLEY**

PACK #01

SURFACE	DIMENSIONS
12m ²	4x3m



PACK #02

SURFACE	DIMENSIONS
18m ²	6x3m



PACK #03

SURFACE	DIMENSIONS
24m ²	6x4m

PACK #04

SURFACE	DIMENSIONS
28m ²	7x4m



CRÉATION/DESIGN CONCEPTION 3D

Pour toutes vos réalisations PLV/STAND EXPO,
nos designers conçoivent, pour vous, votre projet en 3D

CONSULTEZ-NOUS!

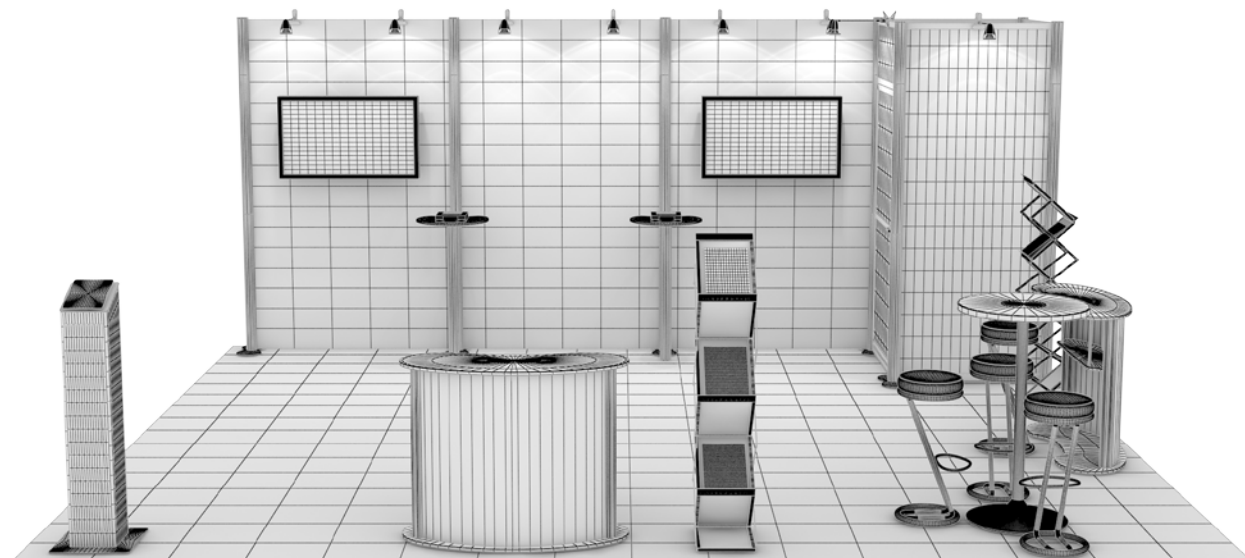

Multidisplays

un kakémono

Nos **multidisplays** sont des produits **modulables** conçus autour d'un mât sur lequel se fixent, selon vos besoins, différents supports de communication : porte-brochures, cadre d'affichage, tablettes porte-produits, kakémonos, etc.

- ✓ MÂT EN ALUMINIUM
- ✓ 192CM DE HAUTEUR
- ✓ KAKÉMONO QUADRI NUMÉRIQUE HD
- ✓ LÉGER & FACILEMENT TRANSPORTABLE
- ✓ POSSIBILITÉS INFINIES !

de nombreux accessoires

> **MD0005**
3 porte-brochures A4.
1 kakémono 60x140 cm



Les éléments

RÉF. ECRAN_15
RÉF. ECRAN_19_2GO
Écrans LCD
avec support de fixation



RÉF. MS_MAT
Mât en aluminium 4 rainures
187 cm de hauteur
Démontable en 2 parties
Poids : 12kg

Cadres snapframe
AFMA03_A4
AFMA03_A3
AFMA03_A2
AFMA03_50x70cm
AFMA03_A1
Autres formats, nous consulter



RÉF. AFM03_A4
Fronton aluminium
personnalisable
Format A4 Paysage

RÉF. MS_PB_MET_A4
Porte-brochure
aluminium A4

Porte-brochure
aluminium A5

Porte-brochure
aluminium 1/3 A4

RÉF. MS_PB_MET_A3
Porte-brochure
aluminium 2x A4

RÉF. POT_MSMAT
Barres porte-kakémono
60 cm de large

Cadres slide-in
recto-verso



AFSU06_A3
AFSU06_A2
AFSU06_A1

RÉF. TAB_MET
Tablette métal
porte-produits
15x30 cm

Platine
450 mm de diamètre

Trolley Bag sur roulettes
RÉF. 5 042 002 021



> MD0019
version simple
2 porte-brochures
2 cadres snapframe
A2 A1



> MD0032
version recto
3 porte-brochures
2xA4 paysage



> MD0040
1 cadre magnétique A1
Fermeture sécurisée par clé

> MD0041
1 cadre liège A1
Fermeture sécurisée par clé



> MD0006
4 porte-brochures A4.
2 cadres slide-in
A2 A1



> MD0017
version simple
1 porte-brochure
1 cadre snapframe
A2 A1

> MD0018
version double
2 porte-brochures
1 cadre snapframe
A2 A1

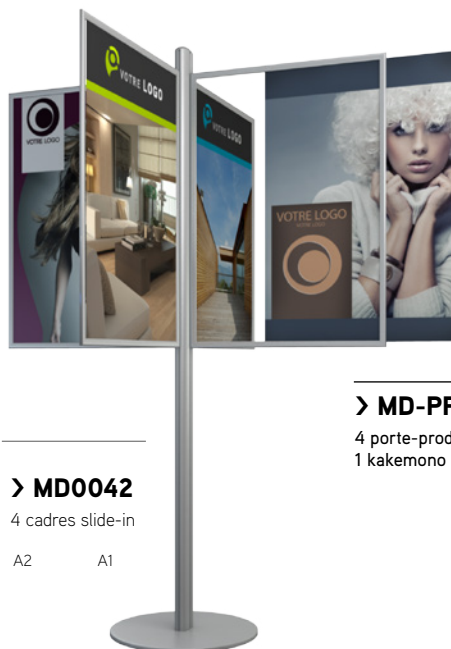

> MD0042
4 cadres slide-in
A2 A1



> MD0027
version recto
2 cadres snapframe
A2 A1



> MD0014
version recto
4 porte-brochures A4
1 cadre snapframe
A2

> MD0015
version recto-verso
4 porte-brochures A4
2 cadres snapframe
A2

a partir de
174,60€

225,50€



> MD-PP
4 porte-produits
1 kakemono 60x140 cm

DRAPEAUX

SHARK BANNER

> S017

Impression en sublimation sur maille polyester
Finition aluminium
Livré avec son pied en croix alourdi

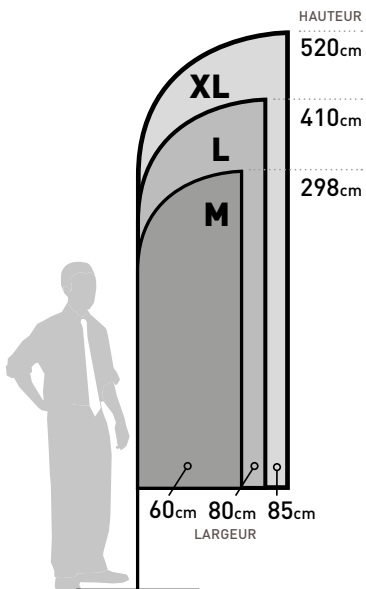

FLYING BANNER

> S009

Impression en sublimation sur maille polyester
Finition noire et argent
Livré avec son pied en croix alourdi

Pieds disponibles en option

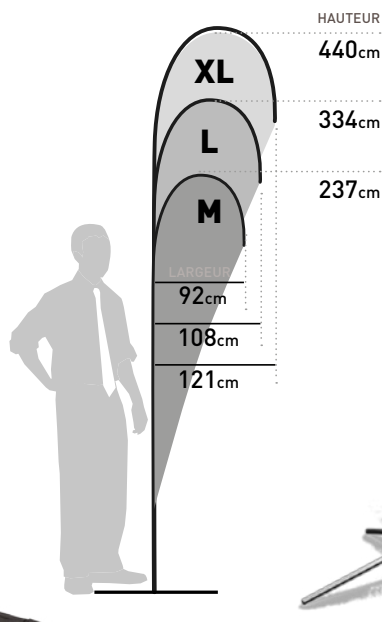

TOUS NOS DRAPEAUX SONT LIVRÉS
AVEC LEUR SAC DE TRANSPORT



FLYING WIND

> S008

Impression en sublimation sur maille polyester
Axe rotatif
Sac de transport inclus
Livré avec son pied lesté
Finition aluminium
(Bouée de lestage en option)

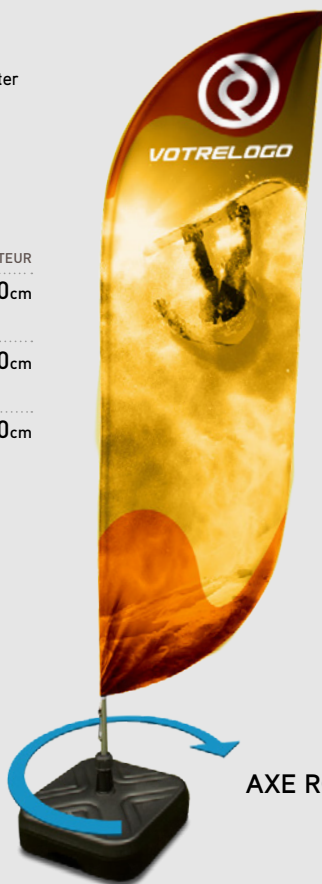
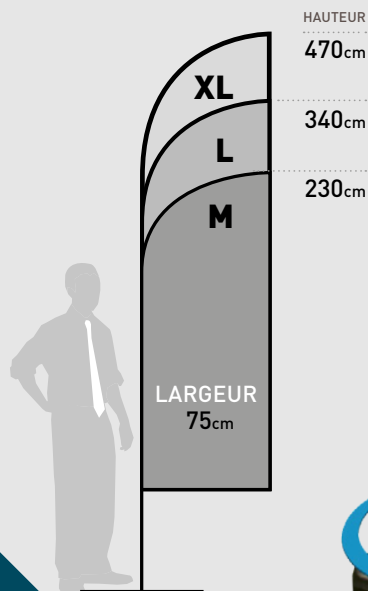

AXE ROTATIF !

SMALL OUTDOOR

> S013

Structure en aluminium
Impression bâche extérieure avec œillets
Sac de transport inclus
Base en plastique à remplir d'eau ou de sable
Couleur gris.
Poids: 6,5kg.

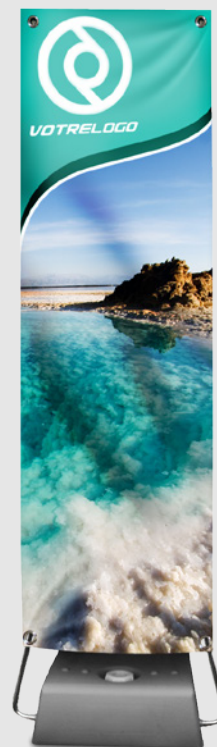
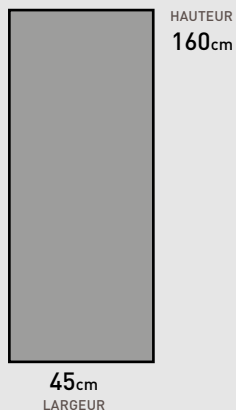

TENTES PLIABLES



TENTE STANDARD

> TENTE
Prise au sol 300x300cm
Parois latérales en option

Structure facilement dépliable et transportable
Livrée avec sac de transport
Idéale pour les événements outdoor
Impression quadri en sublimation



TENTE XL

> TENTE_XL
Prise au sol 450x300cm
Parois latérales en option



TENTE UNIE

Idem tente standard
Disponible en blanc ou en noir



Assurez la stabilité
de votre tente grâce à
nos lests (en option)

TÉLESCOPIQUE FLAG

> SO14
Impression en sublimation sur maille polyester
Mât télescopique en aluminium à hauteur réglable
Platine acier de 11kg

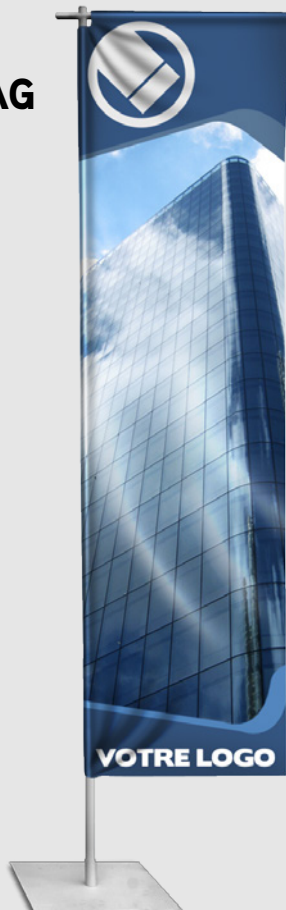
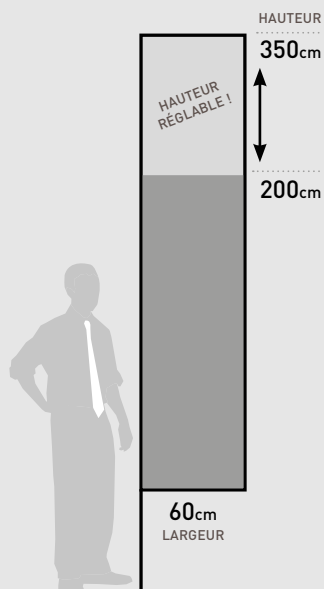

GIANT FLAG

> SO01
Structure aluminium
Hauteur réglable jusqu'à 5,40m
Base en plastique à lester (eau ou sable)
Finition argent

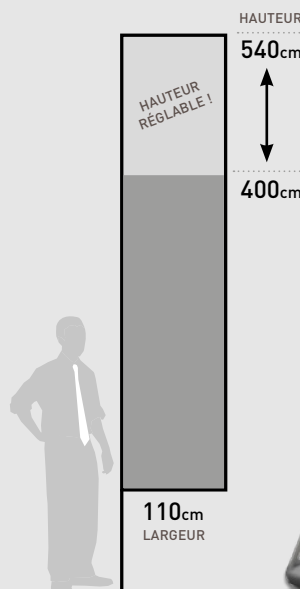



SNAPFRAME CR-04

Cadre Snapframe
Plaques PVC anti-reflets
Finition aluminium

A1

**DOUBLE
FACE**

A0

**RÉSISTANT
À LA PLUIE**

120x176cm

**RÉSISTANT
AU VENT**

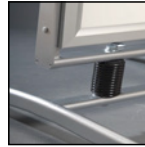

SNAPFRAME CR-15

Cadre Snapframe
Plaques PVC anti-reflets
Finition aluminium

A1

**DOUBLE
FACE**

A0

**FRONTON
NOUS CONSULTER**

**PORTE-BROCHURES
NOUS CONSULTER**



REF	FORMAT	POIDS
CR04-A1	A1	N.C.
CR04-A0	A0	N.C.
CR04-120X176	120X176	N.C.

REF	FORMAT	POIDS
CR15-A1	A1	11kg
CR15-A0	A0	18kg



CHEVALET BOIS CR-BOIS

Chevalet en bois
Cadre en ardoise

A1

**DOUBLE
FACE**

Dimensions extérieures
L.660xH.980mm

Dimensions de l'ardoise
L.560xH.860mm



SNAPFRAME CR-16

Cadre Snapframe
Plaques PVC anti-reflets
Finition aluminium
Fronton intégré
Porte-brochures en option

A1

**DOUBLE
FACE**

**PORTE-BROCHURES
NOUS CONSULTER**

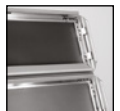

REF	FORMAT	POIDS
CRBOIS	A1	7,9kg

REF	FORMAT	POIDS
CR16	A1	15kg

SNAPFRAME CR-01

Cadre Snapframe
Plaques PVC anti-reflets
Base de lestage en plastique

- A1** DOUBLE FACE
- A0** RÉSISTANT À LA PLUIE
- RÉSISTANT AU VENT



SNAPFRAME CR-05

Cadre Snapframe
Plaques PVC anti-reflets
Finition aluminium

- A1** DOUBLE FACE

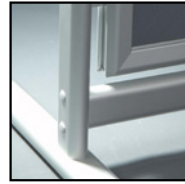

STOP-TROTTOIR

REF	FORMAT	POIDS
CR01-A1	A1	11kg
CR01-A0	A0	14kg

REF	FORMAT	POIDS
CR05	A1	12kg



RÉTRO-ÉCLAIRÉ LED

Chevalet lumineux
Eclairage LED
Autonome sur batterie
Base de lestage
Roulettes intégrées

- A1** ÉCLAIRAGE LED
- AUTONOME SUR BATTERIES
- DOUBLE FACE



MOBILE LIGHT

Cadre LED sur pied
Roulettes intégrés
Très forte luminosité
Alimentation secteur
Utilisation extérieure

- A1** ÉCLAIRAGE LED
- DOUBLE FACE



REF	FORMAT	POIDS
CRLED	A1	N.C.

REF	POIDS
MOBILE_LIGHT_OUT	15kg

SÉLECTION MEILLEURES VENTES

DIGITAL BOOK
> P.24



**TOTEM
55" FULL HD**
"Oregon"
> P.07



**TOTEM
FLYER 22"**
"Astoria"
> P.05



**TOTEM
FLYER 22"**
"Springfield"
> P.06



**BORNE
IPAD DESIGN**
> P.26



**PUPITRE
TACTILE 22"**
"Charleston"
> P.14



TOTEM
42" TACTILE
 "Sublimity"
 > P.16



BORNE
55" TACTILE
 "Sublimity"
 P.16



BORNE
32" DESIGN
 "Woodburn"
 P.15



BORNE
22" TACTILE
 "Sheridan"
 P.12



TOTEM
LCD
 "Portland"
 P.04



TOTEM
DESIGN PRO
 "Gladstone"
 P.11



SÉLECTION MEILLEURES VENTES

CADRE MURAL
AFM03
> P.39



STAND PARAPLUIE PVC
SI21-3x3
> P.58



PORTE-BROCHURES
SI25
> P.42



PORTE-BROCHURES
PB600
> P.42



COMPTOIR POP-UP
SI3300
> P.68



PORTE-BROCHURES
SI2500
> P.42



CENTRO CONSOLE
SI41
> P.44



PORTE-VISUEL
DELTA FOOT
> P.46



ROLL-UP INITIAL
SI14
> P.64



X-BANNER
SI08-SMALL
> P.66

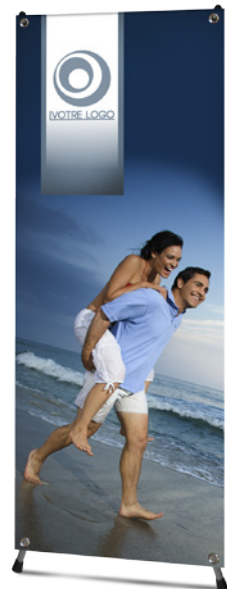

MULTIDISPLAY
MD0005
> P.78



STOP-TROTTOIR
CR15
> P.82





PLV | STANDS EXPO | SIGNALETIQUE | DIGITAL

————— VENTE & LOCATION —————